

List of pages in this Trip Kit

Trip Kit Index

Airport Information For RKPK

Terminal Charts For RKPK

Revision Letter For Cycle 07-2023

Change Notices

Notebook

General Information

Location: BUSAN KOR
ICAO/IATA: RPKK / PUS
Lat/Long: N35° 10.83', E128° 56.28'
Elevation: 13 ft

Airport Use: Joint-Use
Daylight Savings: Not Observed
UTC Conversion: -9:00 = UTC
Magnetic Variation: 8.0° W

Fuel Types: Jet A-1
Customs: Yes
Airport Type: IFR
Landing Fee: Yes
Control Tower: Yes
Jet Start Unit: No
LLWS Alert: No
Beacon: Yes

Sunrise: 2053 Z
Sunset: 0956 Z

Runway Information

Runway: 18L
Length x Width: 8999 ft x 151 ft
Surface Type: concrete
TDZ-Elev: 8 ft
Lighting: Edge, ALS, Centerline

Runway: 18R
Length x Width: 10499 ft x 197 ft
Surface Type: concrete
TDZ-Elev: 13 ft
Lighting: Edge, ALS, Centerline, REIL
Displaced Threshold: 1969 ft

Runway: 36L
Length x Width: 10499 ft x 197 ft
Surface Type: concrete
TDZ-Elev: 13 ft
Lighting: Edge, ALS, Centerline, TDZ

Runway: 36R
Length x Width: 8999 ft x 151 ft
Surface Type: concrete
TDZ-Elev: 8 ft
Lighting: Edge, ALS, Centerline, TDZ

Communication Information

ATIS: 126.600
ATIS: 23.510 Military
Gimhae Tower: 118.450
Gimhae Tower: 118.100
Gimhae Tower: 23.660 Military
Gimhae Tower: 23.330 Military
Gimhae Ground: 121.900
Gimhae Ground: 27.580 Military
Gimhae Ramp/Taxi: 31.745 Military
Gimhae Ramp/Taxi: 121.650
Gimhae Clearance Delivery: 121.725
Gimhae Clearance Delivery: 121.800 Military
Gimhae Clearance Delivery: 22.952 Military
Gimhae Approach: 125.500
Gimhae Approach: 36.400 Military
Gimhae Arrival: 119.200
Gimhae Arrival: 134.400
Gimhae Arrival: 23.010 Military
Gimhae Arrival: 25.380 Military
Gimhae Departure: 125.500
Gimhae Departure: 36.380

GIMHAE TERMINAL CONTROL AREA

Gimhae App (R) 125.5

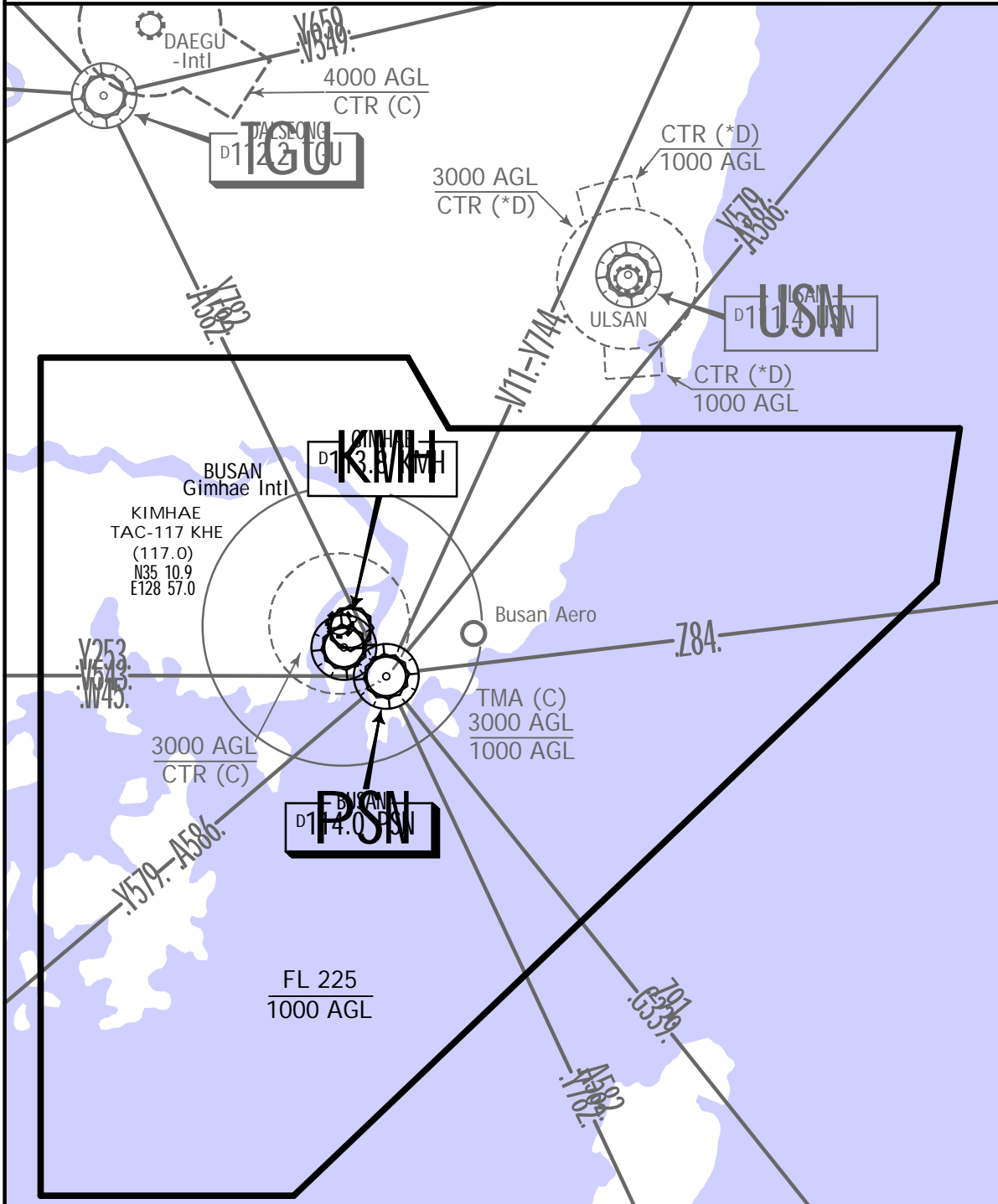

.SPEED. RESTRICTIONS WITHIN KOREAN AIRSPACE
 All Arrivals into RKSS and RKSJ shall operate in accordance with the flight procedures for that airport.
 Maximim IAS unless otherwise authorized by ATC:
 BELOW 10000'250 KTS
 Class C and Class D Airspace:
 At or below 2500' AGL within 4NM of an Airport..200 KTS

1. GENERAL

1.1. ATIS

D-ATIS 126.6

1.2. Airport Regulations

1.2.1 GIMHAE Airport Runway strip is not satisfied with ICAO safety standard at the moment. Therefore, refer to the following advice for aviation safety. If the value of the surface friction measurements is less than 0.2, refrain from aircraft operation.

1.2.2. Flight limitations

- The use of airport for training purpose is prohibited. The deliberate simulation of engine failure is not permitted whilst on approach to or departure from the airport.
- The use of airport by light sports aircraft, ultra-light vehicles and lighter than air is prohibited.

2. ARRIVAL

2.1. The procedures of using Taxiway

Unless otherwise instructed, aircraft should use the following routes:

- RWY 36L in use: C1 - E1 - P - Apron / C2 - E2 - P - Apron
- RWY 36R in use: E1 - P - Apron / E2 - P - Apron
- RWY 18L in use: E3 - P - Apron / E4 - P - Apron / E5 - P - Apron
- RWY 18R in use: C5 - E4 - P - APRON / C6 - E5 - P - APRON
- C7 - E5 - P - APRON / S - P - APRON
- When necessary, other taxiways can be used under TWR permission.

2.2. Arrival routes and Radio Frequency Transfer Points (RTP)

2.2.1. Unless otherwise instructed, aircraft should use the following routes:

Apron	RWY in use	Route		Ground FREQ	R T P		Apron FREQ
		Fixed wing	HEL		Fixed wing	HEL	
Domestic, International 1 and 2	36L	G7, G10	G7, G11	121.9	G7 (hold line), G10 (hold line)	G7 (hold line), G11 (hold line)	121.65
	36R	G7, G9			G7 (hold line), G9 (hold line)		
	18L	G10			G10 (hold line)		
	18R	G10			G10 (hold line)		

2.2.2. Aircraft will normally be transferred to GIMHAE APRON prior to the RTP. Unless otherwise directed, aircraft may automatically contact GIMHAE APRON at the RTP.

2.2.3. Aircraft shall not proceed beyond the RTP without clearance from GIMHAE APRON.

2.3. Follow-me car service

2.3.1. Follow-me service is available to arriving aircraft. Pilots should make the request to GIMHAE GROUND or GIMHAE APRON.

2.3.2. Aircraft shall monitor the appropriate GIMHAE GROUND and/or GIMHAE APRON frequencies while taxiing.

2.4. CAT II Operations

2.4.1. General

Gimhae International Airport RWY 36L has ILS CAT II equipment.

Low visibility Procedures are established for operation in visibility of less than RVR 550m or a cloud ceiling of less than 60m (200').

1. Low visibility operations will be initiated by broadcasting "ATC LOW VISIBILITY PROCEDURES ARE IN OPERATION" via ATIS and/or appropriate radio frequencies.
2. Low visibility operations will be terminated by deleting the above mentioned message from ATIS and/or broadcasting "ATC LOW VISIBILITY OPERATIONS ARE TERMINATED" via appropriate frequencies.

2.4.2. Aircraft operator must obtain the approval from Administrator of Busan Regional Office of Aviation prior to conducting any low visibility operations at Gimhae International Airport.

1. Approval for CAT II Operations

a. Aircraft operators and pilots who wish to conduct ILS CAT II operations at Gimhae International Airport shall conform with certain requirements.

b. Foreign operators may obtain the approval from Administrator of Busan Regional Office of Aviation by providing the following information to Administrator of Busan Regional Office of Aviation

- 1) Aircraft type and register number;
- 2) The Category II minima under which they intend to operate; and
- 3) A copy of the category II certification issued by their own category authority.

2. ARRIVAL (CONTD)

2.4.3. Pilots shall be informed when:

1. Meteorological reports preclude ILS CAT I operations;
2. Low Visibility Procedures are in operation;
3. There is any unserviceability in a promulgated facility so that they may amend their minima.

2.4.4. When informed the failure of Surface Movement Radar (SMR), pilots should anticipate that considerable spacing between the aircraft may be required.

2.4.5. Pilot who wish to carry out an ILS CAT II approach shall inform Approach Control on their initial contact.

2.4.6. Special Procedures and Safeguards

General Special Procedures and ground safeguards

Special procedures and ground safeguards will be applied during CAT II operations to protect the aircraft from operating in low visibility and to avoid interference with ILS signals in accordance with the provisions of ICAO Doc. 9365- Manual of All Weather Operations, and the provisions of the Enforcement Regulations of Aviation Safety Act, Article of 248.

1. Arriving Aircraft

- a. Aircraft shall vacate the runway via the designated exit taxiways as follows:
RWY 36L- C1, C2, C3, C4, E1, E2, E3, P (LOW VIS ARR TAXI ROUTE Rwy 36L)
- b. Pilots are required to make a 'runway vacated' call, when entire aircraft has cleared the ILS critical sensitive areas.

2. Departing aircraft

Aircraft shall normally enter the runway via the designated taxiways as follows:

- RWY 36L - G8, G11, P, S (Refer to LOW VIS DEP TAXI ROUTE Rwy 36L)
- RWY 36R - G8, G10, P, E5 (Refer to LOW VIS DEP TAXI ROUTE Rwy 36R)
- RWY 18L - G7, G8, G11, P, E1,
- RWY 18R - G7, G8, G11, P, E1, C1 (Refer to LOW VIS DEP TAXI ROUTE Rwy 18L/R)

3. Unless otherwise cleared by ATC, all aircraft should be restricted to taxi within the apron in a visibility of less than RVR 350m.

4. Refer to CODE F ACFT OPERATIONS, Figure 1 CODE F ACFT OPERATIONS (CONTD), and Figure 2 CODE F ACFT OPERATIONS (CONTD1) for the taxi procedures of the code F ferry flight aircraft.

2.4.7. Practice Approaches

Pilots may carry out the practice of ILS CAT II approach at any time with a prior approval from ATC, but the full safeguarding ground procedures shall not be applied and pilots should anticipate the possibility of ILS signal interference.

2.5. Speed restrictions

2.5.1. All aircraft shall not exceed 250 KT IAS below 10,000' AMSL in GIMHAE TMA, unless otherwise authorized by ATC. If the minimum safe speed is greater than 250 KT IAS, the aircraft may maintain the minimum safe speed without ATC authorization.

2.5.2. When ILS Rwy 36L and 36R approach in use, civil aircraft should comply with the following speed restrictions. If unable to comply, ATC may instruct speed restrictions.

Approach Segments	Speeds
Initial approach phase	220 KT IAS or above
Base leg/heading to final approach	180KT IAS - 220KT IAS
Established on final approach to 8 DME	160KT IAS - 180KT IAS

2.5.3. When ATC uses "NO [ATC] SPEED RESTRICTIONS" RTF phraseology, pilot shall note that all speed control restrictions are cancelled and preferred speed may be flown without any speed restrictions.

2.5.4. When ATC uses "RESUME NORMAL SPEED" RTF phraseology, pilot shall note that the previously issued speed restriction by ATC is cancelled but comply with GIMHAE TMA speed restriction (MAX 250 KT IAS below 10,000').

3. DEPARTURE

3.1 ATC Clearance

Departing IFR flights shall contact GIMHAE delivery (121.725) to obtain ATC clearance at least 5 minutes prior to pushback.

3.2 Procedures for start-up and push back

- 1) When ready to push back, aircraft contact GIMHAE APRON and provide the following:
 - a. Call sign
 - b. Gate or stand number
 - c. Release time (if necessary)
- 2) Ground crews (Ground handler, aircraft maintenance) must ensure that the area behind the aircraft shall be clear of vehicles, equipment and other obstructions prior to engine start-up or aircraft push back for smooth and safe aircraft movements.
- 3) A pilot shall confirm with ground crews (Ground handler, aircraft maintenance) whether there is no hazard to the aircraft starting up. The pilot shall not ask GIMHAE APRON for engine start-up and push back until its safety check-up is fully confirmed. If there are any elements posing a potential failure, the pilot shall ask GIMHAE APRON for push back only.
After moving and standing the aircraft at a safety area, the pilot can ask for engine start-up.
- 4) All aircraft to be taxied within the Apron shall fix the engine thrust to idle. In case of using breakaway thrust, it should be used to a minimum.
- 5) The following table describes the procedures for the push back of aircraft from the various aircraft stands. When it becomes necessary to vary a procedure to expedite aircraft movements, GIMHAE APRON CONTROL will provide specific instructions to the pilot.

Aircraft Stands	Push Back Procedures	Phraseology
1-9, 19-24 26-29	The aircraft shall be pushed back to face south (or north)	Push back approved, to face south (or north)
10	The aircraft shall be pushed back to face south (or north)	Push back approved, to face south (or north)
	When the aircraft is required to perform one-engine start using ASU (Air Start Unit) on the aircraft stand, ground crews must ensure that the area behind the aircraft shall be clear of vehicles, equipment and other obstacles prior to engine start-up.	-
11	The aircraft shall be pushed back till its nosewheel is at the start point 4 (or pushed back to face north)	Push back approved, to start-point 4 (or to face north)
	When the aircraft is required to perform one-engine start using ASU (Air Start Unit) on the aircraft stand, ground crews must ensure that the area behind the aircraft shall be clear of vehicles, equipment and other obstacles prior to engine start-up.	-
25	The aircraft shall be pushed back to face south (or north)	Push back approved, to face south (or north)
	Self-maneuvering is permitted for ACFT with a wingspan less than 102' (31 m). Ground crews(ground handler, aircraft maintenance) must ensure that the area near the self-maneuvering path shall be clear of vehicles, equipment and other OBST prior to engine start-up for smooth and safety aircraft movements.	-
41	The aircraft shall be pushed back and towed forward till its nosewheel is at the start point 1	Push back approved, to start-point 1
12, 31-38, 42-48	The aircraft shall be pushed back till its nosewheel is at the intersection of lead-in line and taxi lane	Push back approved
52, 55, 55L, 55R	The aircraft shall be pushed back till its nosewheel is at the start point 2 (or 3)	Push back approved, to start-point 2 (or 3)
53, 53L, 53R, 54, 54L, 54R	The aircraft shall be pushed back till its nosewheel is at the start point 2	Push back approved, to start-point 2
51, 58, 58L, 58R	The aircraft shall be pushed back till its nosewheel is at the start point 3	Push back approved, to start-point 3

3. DEPARTURE (CONTD)

Aircraft Stands	Push Back Procedures	Phraseology
51L	The aircraft shall be pushed back till its nosewheel is at the start point 3	Push back approved, to start-point 3
	When 51R stand is occupied by aircraft with a wingspan less than 66' (20.01m) or unoccupied, self-maneuvering is permitted for aircraft with a wingspan less than 66' (20.01m)	-
51R	The aircraft shall be pushed back till its nosewheel is at the start point 3	Push back approved, to start-point 3
	When 51L stand is occupied by aircraft with a wingspan less than 66' (20.01m) or unoccupied, self-maneuvering is permitted for aircraft with a wingspan less than 66' (20.01m)	-
57	The aircraft shall be pushed back till its nose-tip has crossed east side of GSE road and faces west	Push back approved, to face west

3.3 Departure routes and Radio Frequency Transfer Points (RTP)

3.3.1. Unless otherwise instructed, aircraft should use the following routes:

Apron	RWY in use	Route		Apron FREQ	R T P		Ground FREQ
		Fixed wing	HEL		Fixed wing	HEL	
Domestic, International 1 and 2	36L	G8, G11	G7, G11	121.65	G8 (hold line), G11 (hold line)	G7 (hold line), G11 (hold line)	121.9
	36R	G8, G10			G8 (hold line), G10 (hold line)		
	18L	G7, G9			G7 (hold line), G9 (hold line)		
	18R	G7, G9			G7 (hold line), G9 (hold line)		

3.3.2. Aircraft will normally be transferred to GIMHAE GROUND prior to the RTP. Unless otherwise directed, aircraft may automatically contact GIMHAE GROUND at the RTP.

3.3.3. Aircraft shall not proceed beyond the RTP without clearance from GIMHAE GROUND.

3.4 The procedures of using Taxiway

Unless otherwise instructed, aircraft should use the following routes:

- RWY 36L in use: Apron - P - S or E5 - C7
- RWY 36R in use: Apron - P - E5
- RWY 18L in use: Apron - P - E1
- RWY 18R in use: Apron - P - E1 - C1
- When necessary, aircraft obtained intersection take-off clearance from the TWR may proceed to RWY through central taxiways.
- Aircraft standing on KAL parking area (PDM) located in the west part of AD shall proceed to RWY through "W2" or "W3" taxiway.

3.5. Deicing Operations

3.5.1. Deicing Pad is located on G8, G9(Enable up to B-747), Aircraft stand 26 and 27.

3.5.2. Deicing Pad Operation

- Aircraft Operator shall notify the Ground Operator when he/she wants to use deicing pad.
- Ground Operator shall notify the relevant government as to Operation Procedure.
- When using a deicing pad, notify GIMHAE APRON (121.65) before push back (Verify completion, ready for departure).

3.5.3. Deicing Pad Movement

- Aircraft Operator shall maintain communication while deicing.
- If an aircraft is deicing at G9, GIMHAE APRON shall notify all aircraft taxiing on G10 and G11.

RADIO COMMUNICATION FAILURE PROCEDURE

IFR

1. General

- a. No person may take off unless two-way radio communications can be maintained with the Air Traffic Control.
- b. On recognition of communication failure during flight, squawk 7600 and if necessary to ensure safe altitude, climb to Minimum Safe Altitude or above to MAINTAIN obstacle clearance. Then comply with following procedure.

2. VFR condition

If the failure to radio communication occurs in VFR conditions, or if VFR conditions are encountered after the failure, a pilot shall continue the flight under VFR and land as soon as practicable based on the runway in use.

3. IFR condition

If the failure occurs in IFR condition, or if the requirements specified in paragraph 2 of this section cannot be met, a pilot shall continue the flight according to the following procedures:

A. DEPARTURE

a. Under Pilot Navigation

- 1) Follow the SID with altitude/flight level assigned at the last ATC clearance received.

b. Under RADAR Vectoring

- 1) Proceed by the direct route from the point of radio failure to the fix, route, or airway specified in the vector clearance;
- 2) In the absence of an assigned route, proceed by the route that ATC will advise through the forthcoming clearance; or
- 3) In the absence of an assigned route or a route that ATC will advise through the forthcoming clearance, proceed by the route filed in the flight plan; and
- 4) MAINTAIN minimum enroute altitude (MEA) or the altitude/flight level cleared in the last ATC clearance received, whichever is higher, for 20 minutes; then
- 5) Continue the flight with altitude/flight level filed in the flight plan.

B. ARRIVAL

- a. Proceed to GEOJE IAF or NARAE IAF or GAYHA IAF or KEVOX IAF or PEDLO IAF whichever is nearer at the last assigned altitude or the minimum altitude of IAF whichever is higher and hold; then
- b. Execute instrument approach as close as possible to the EXPECT further clearance time (EFC) issued by ATC or estimated time of arrival (ETA) filed in the flight plan; and
- c. Land, if possible, within 30 minutes after ETA or the last acknowledged EFC or ETA, whichever is later.

VFR

VFR flight which has experienced radio communication failure shall:

- Squawk mode 3/A code 7600, and
- When able to see light gun signal of control tower, follow that instruction.
- If unable to see light gun signal of control tower, hold on downwind until ETA or for 10 minutes, whichever is longer, then
- Aircraft on WEST pattern should land on RWY in use.
- Pilot shall use caution, traffic landing and taking-off from/to runways.

RKPK/PUS
GIMHAIE INTL

JEPPESSEN
25 NOV 22 **(10-2A)** .Eff.30.Nov.1600Z.

BUSAN, KOREA
.RNAV.STAR.

*D-ATIS 126.6	Apt Elev 13	Alt Set: hPa Trans level: FL140
		RNAV 1 required GNSS and RADAR required DME/DME/IRU not authorized
Approach procedure not authorized via inbound without holding at GAYHA for ANROD Transition. ATC clearance required.		

GAYHA 3 RNAV (GNSS) ARRIVAL
[GAYHA3]
(RWYS 18L/R)

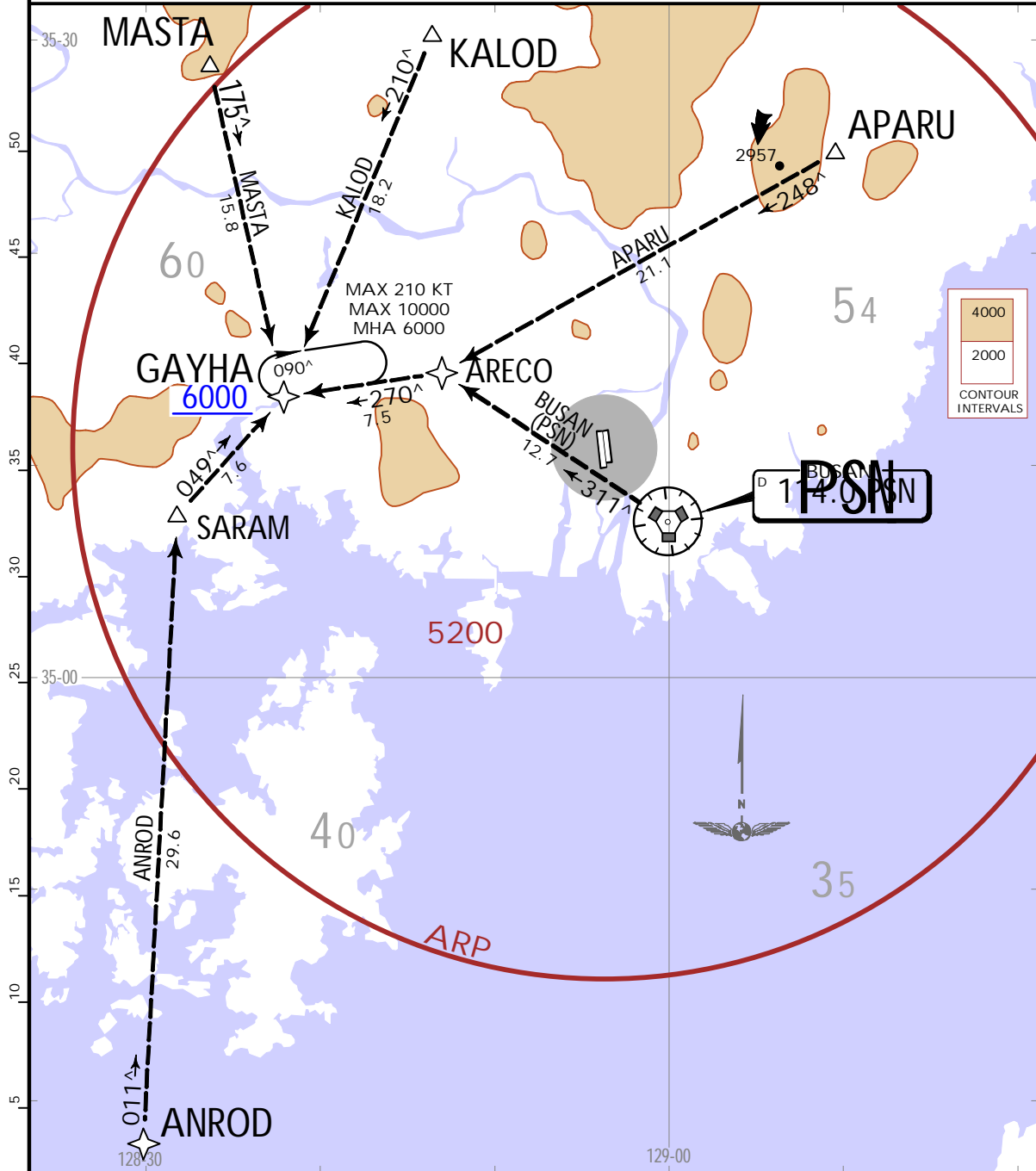

TRANSITIONS	
ANROD	From ANROD on track 011 [^] to SARAM, then track 049 [^] to cross GAYHA at or above 6000.
APARU	From APARU on track 248 [^] to ARECO, then track 270 [^] to cross GAYHA at or above 6000.
BUSAN (PSN)	From BUSAN (PSN VOR) on track 311 [^] to ARECO, then track 270 [^] to cross GAYHA at or above 6000.
KALOD	From KALOD on track 210 [^] to cross GAYHA at or above 6000.
MASTA	From MASTA on track 175 [^] to cross GAYHA at or above 6000.

LANDING
At GAYHA, EXPECT RNAV approach.

RKPK/PUS
GIMHAE INTL

JEPPESEN
25 NOV 22 **10-2B** .Eff.30.Nov.1600Z.

BUSAN, KOREA
.RNAV.STAR.

*D-ATIS 126.6	Apt Elev 13	Alt Set: hPa Trans level: FL140 RNAV 1 required GNS and RADAR required DME/DME/IRU not authorized
------------------	----------------	---

KEVOX 3 RNAV (GNSS) ARRIVAL
[KEVOX3]
(RWYS 36L/R)

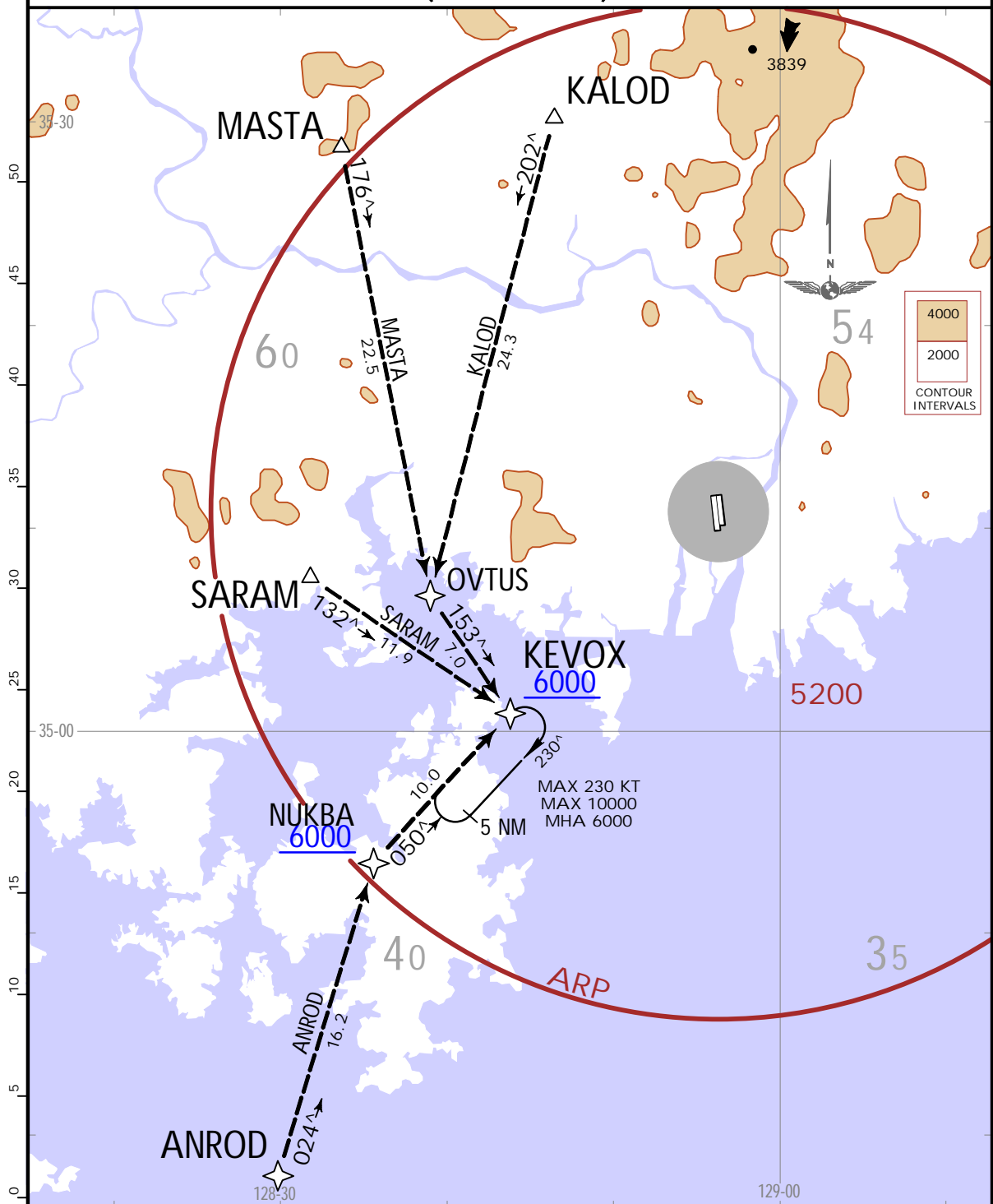

TRANSITIONS

ANROD	From ANROD on track 024° to NUKBA, then track 050° to cross KEVOX at or above 6000.
KALOD	From KALOD on track 202° to OVTUS, then track 153° to KEVOX.
MASTA	From MASTA on track 176° to OVTUS, then track 153° to KEVOX.
SARAM	From SARAM on track 132° to KEVOX.

LANDING

At KEVOX, EXPECT RNAV or ILS approach.

RKPK/PUS
GIMHAE INTL

JEPPesen
25 NOV 22 (10-2C) .Eff.30.Nov.1600Z.

BUSAN, KOREA
.RNAV.STAR.

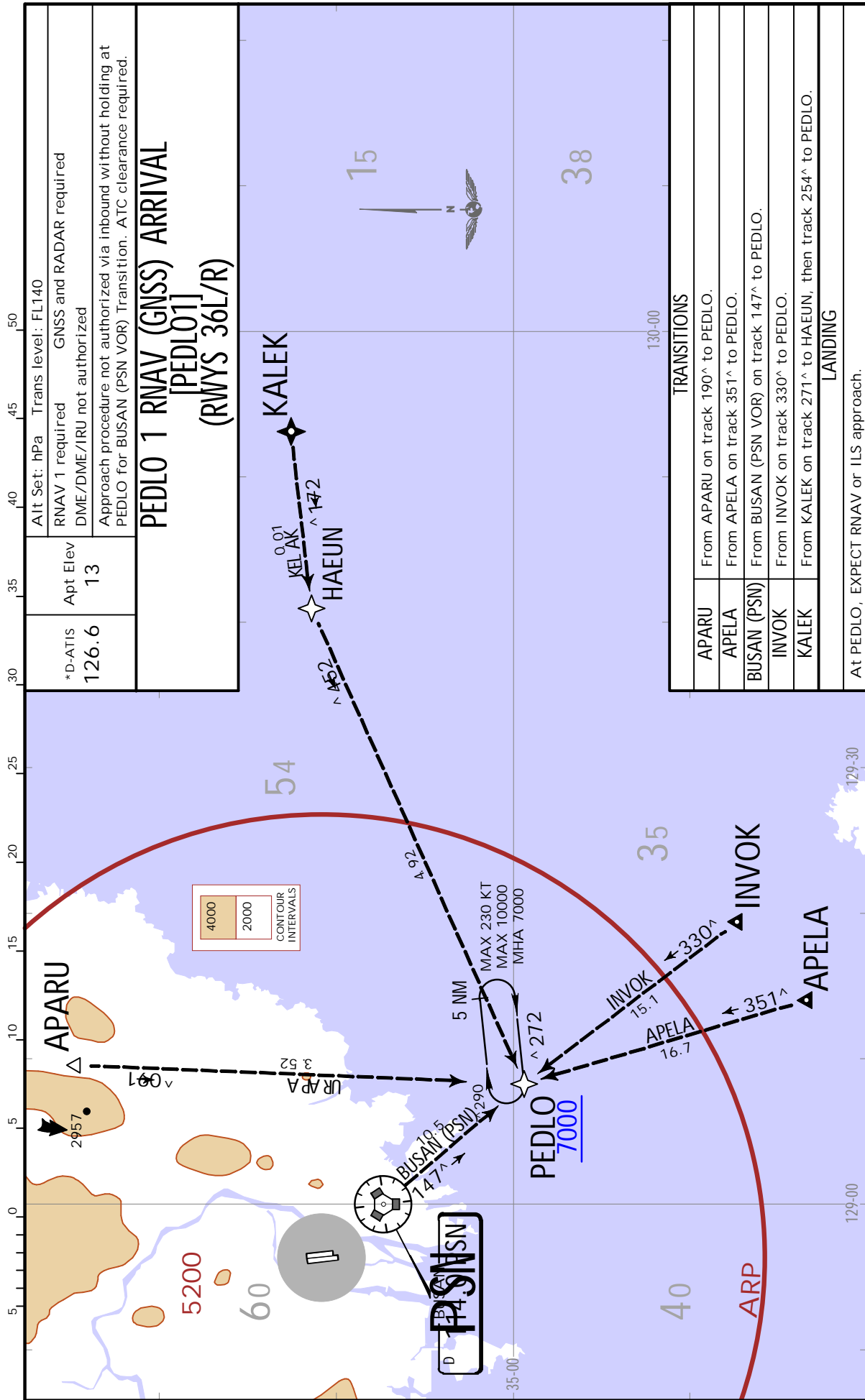

CHANGES: General note added & waypoint symbol at KALEK revised.

RKPK/PUS
GIMHAE INTL

JEPPESEN
31 MAR 23 **10-3**

BUSAN, KOREA
.SID.

GIMHAE Departure (R) 125.5	Apt Elev 13	Trans alt: 14000 1. VOR/DME and RADAR required. 2. All aircraft departing must complete turn within 2 NM from DER after take-off.
--------------------------------------	-----------------------	---

ATLAX 2 DEPARTURE
[ATLAX2]
(RWYS 36L/R)
.SPEED: MAX 240 KT BELOW 6000

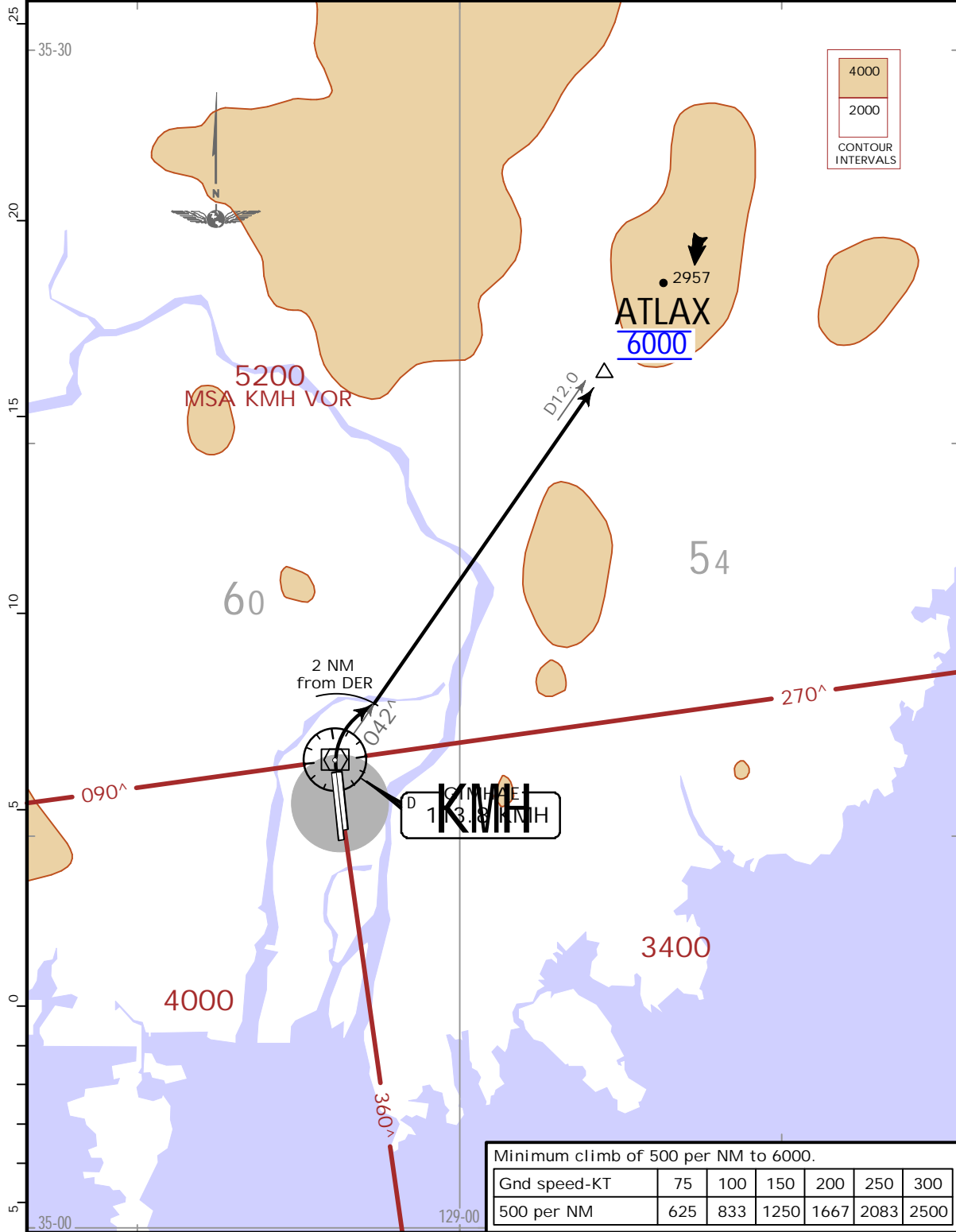

INITIAL CLIMB

Climbing RIGHT turn to intercept KMH R042 and climb to 6000 on KMH R042 to ATLAX, then EXPECT RADAR vectors to assigned route and fix.

RKPK/PUS
GIMHAE INTL

JEPPESEN
31 MAR 23 10-3A

BUSAN, KOREA
.SID.

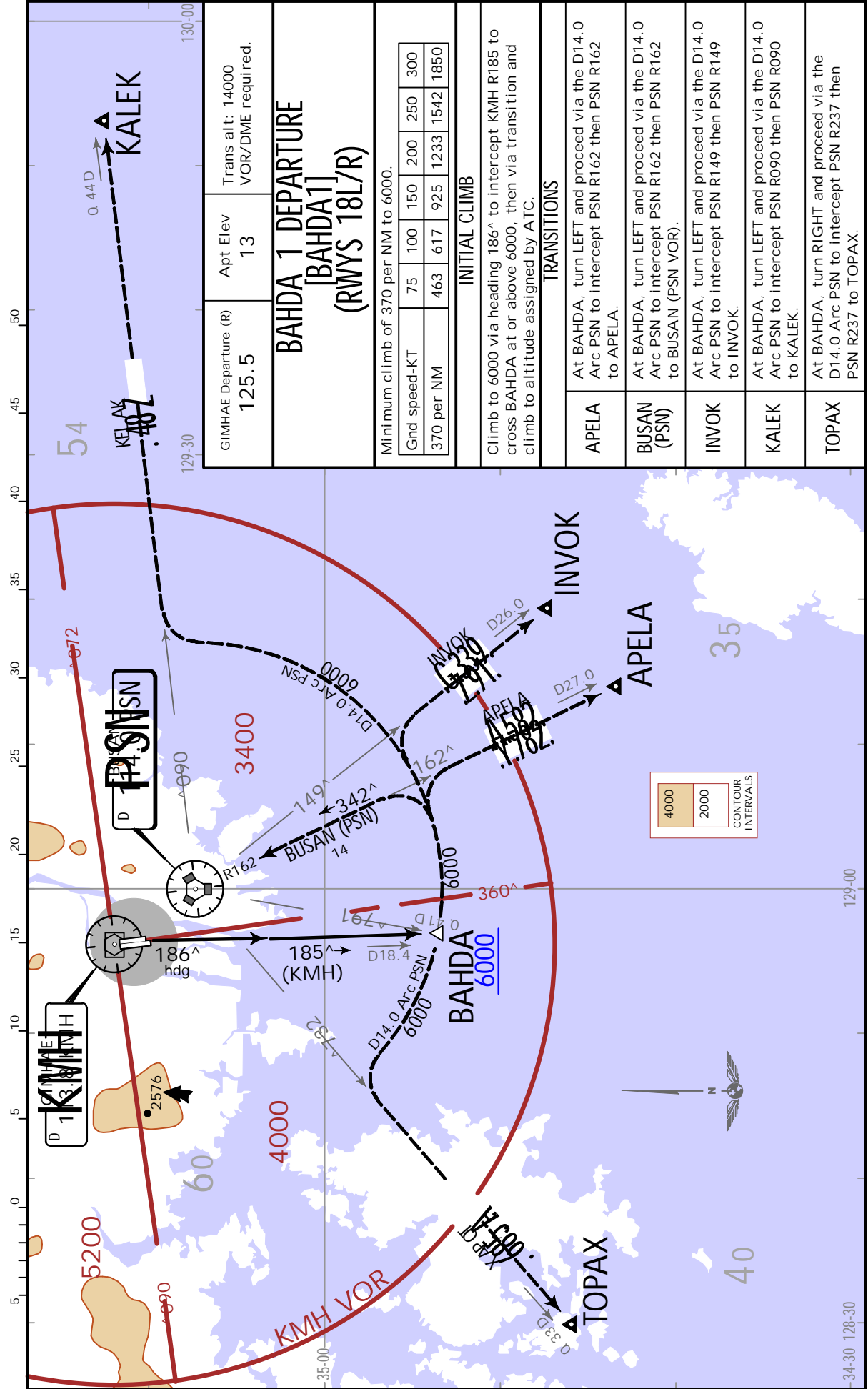

CHANGES: Airway Y-579 withdrawn.

RKPK/PUS
GIMHAE INTL

JEPPESEN

25 NOV 22 **10-3B** .Eff.30.Nov.1600Z.

BUSAN, KOREA
.SID.

GIMHAE Departure (R) 125.5	Apt Elev 13	Trans alt: 14000 1. VOR/DME required. 2. All aircraft departing must complete turn within 2 NM from DER after take-off.
-------------------------------	----------------	---

BEVSI 3 DEPARTURE
[BEVSI3]
(RWYS 36L/R)

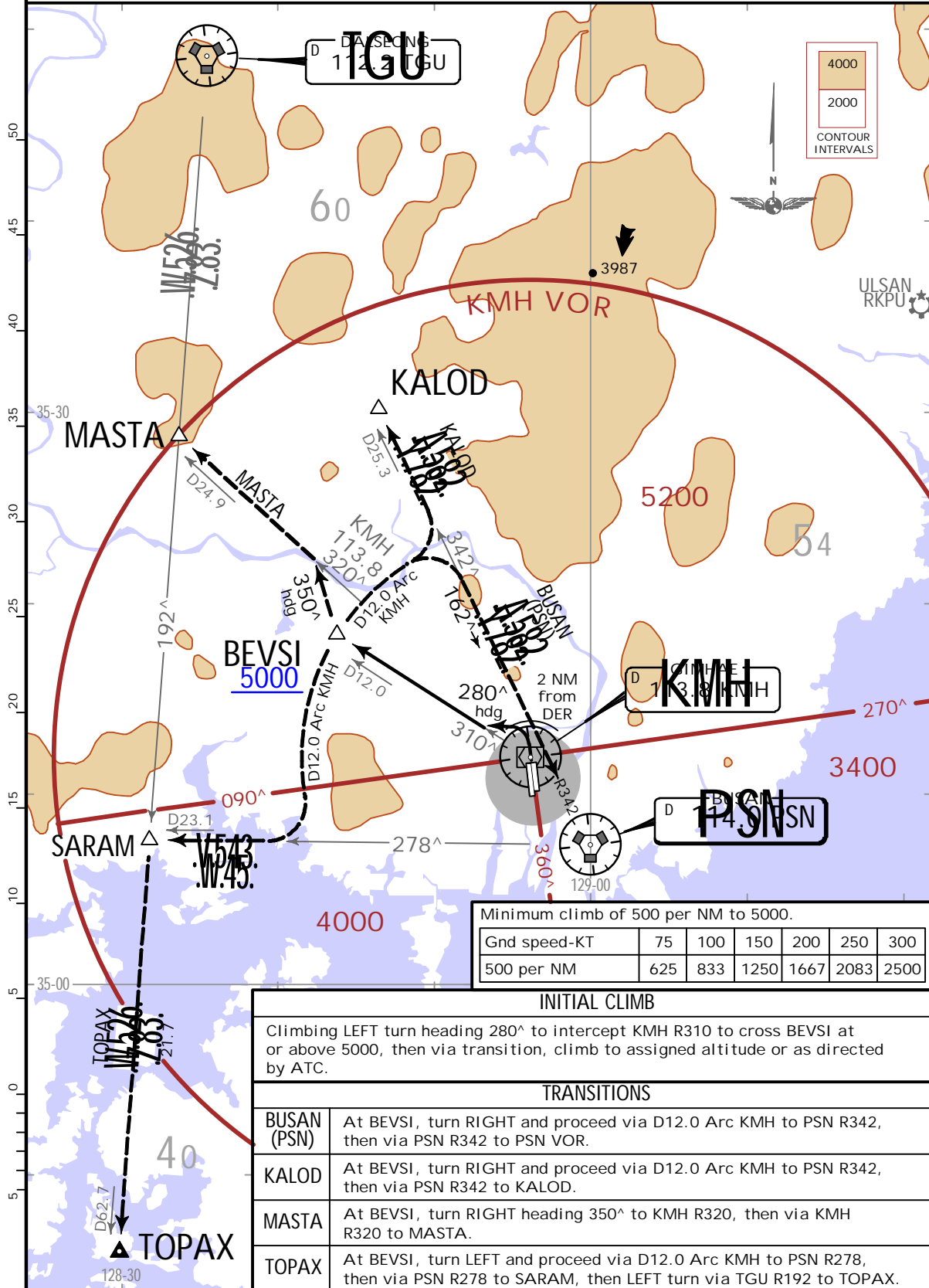

INITIAL CLIMB	
Climbing LEFT turn heading 280° to intercept KMH R310 to cross BEVSI at or above 5000, then via transition, climb to assigned altitude or as directed by ATC.	
TRANSITIONS	
BUSAN (PSN)	At BEVSI, turn RIGHT and proceed via D12.0 Arc KMH to PSN R342, then via PSN R342 to PSN VOR.
KALOD	At BEVSI, turn RIGHT and proceed via D12.0 Arc KMH to PSN R342, then via PSN R342 to KALOD.
MASTA	At BEVSI, turn RIGHT heading 350° to KMH R320, then via KMH R320 to MASTA.
TOPAX	At BEVSI, turn LEFT and proceed via D12.0 Arc KMH to PSN R278, then via PSN R278 to SARAM, then LEFT turn via TGU R192 to TOPAX.

RKPK/PUS
GIMHAE INTL

JEPPESEN
25 NOV 22 (10-3C) .Eff.30.Nov.1600Z.

BUSAN, KOREA
.RNAV.SID.

GIMHAE Departure (R) 125.5	Apt Elev 13	Trans alt: 14000
		RNAV 1 required RADAR and GNSS required DME/DME/IRU not authorized

BURIM 3 RNAV (GNSS) DEPARTURE
[BURIM3]
(RWYS 18L/R)
.SPEED: DO NOT EXCEED 230 KT UNTIL BURIM AND PK514

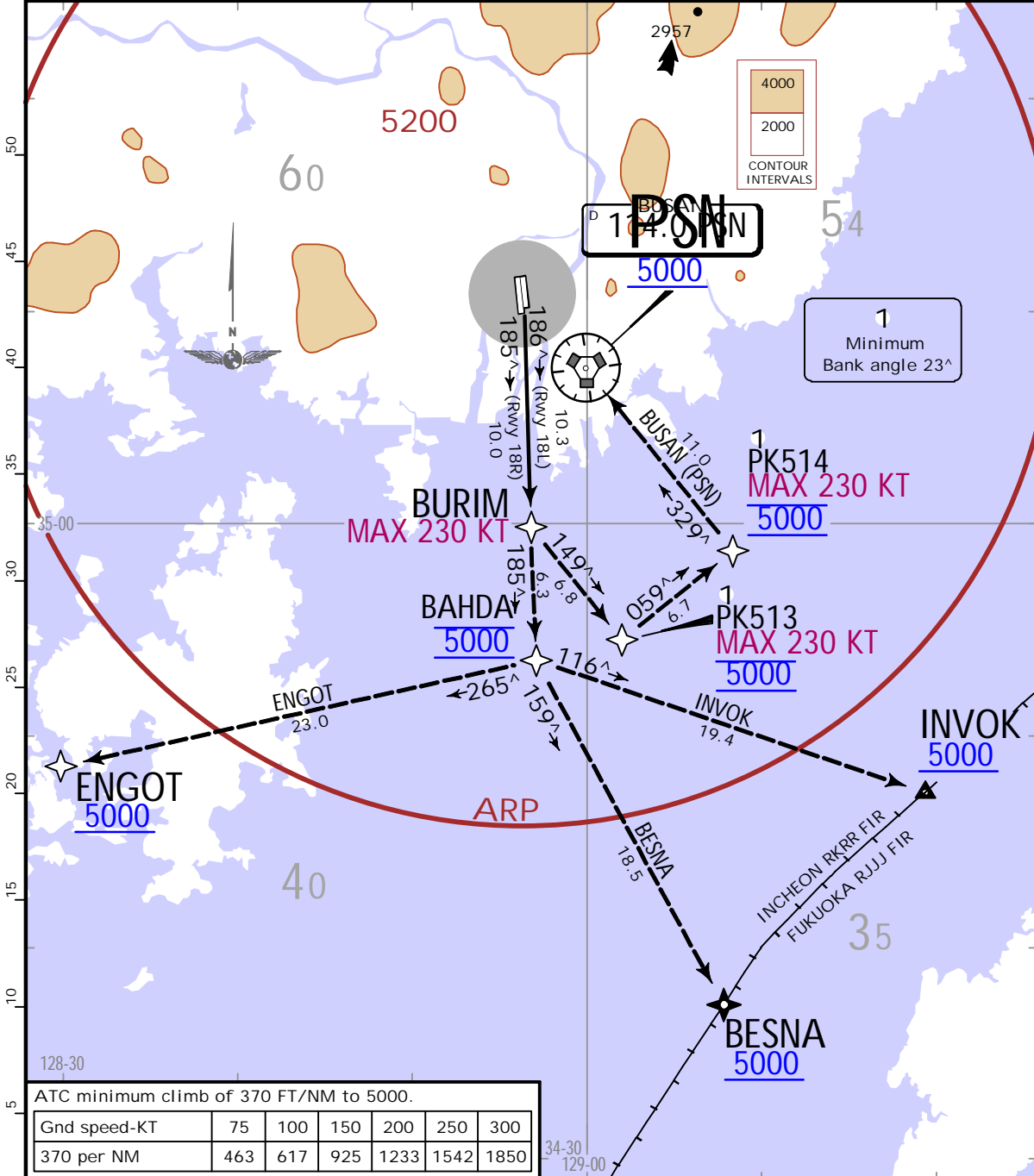

128-30
ATC minimum climb of 370 FT/NM to 5000.

Gnd speed-KT	75	100	150	200	250	300
370 per NM	463	617	925	1233	1542	1850

RWY	INITIAL CLIMB
18L	Climb on course 186° to BURIM, then via transition and climb to altitude assigned by ATC.
18R	Climb on course 185° to BURIM, then via transition and climb to altitude assigned by ATC.
TRANSITIONS	
BESNA	At BURIM on track 185° to cross BAHDA at 5000, then on track 159° to BESNA.
BUSAN (PSN)	At BURIM on track 149° to cross PK513 at 5000, then on track 059° to cross PK514 at 5000, then on track 329° to cross BUSAN (PSN VOR) at or above 5000.
ENGOT	At BURIM on track 185° to cross BAHDA at 5000, then on track 265° to ENGOT.
INVOK	At BURIM on track 185° to cross BAHDA at 5000, then on track 116° to INVOK.

RKPK/PUS
GIMHAE INTL

JEPPESSEN
31 MAR 23 (10-3D)

BUSAN, KOREA
.SID.

GIMHAE Departure (R) 125.5	Apt Elev 13	Trans alt: 14000 1. RADAR required. 2. All aircraft departing must complete turn within 2 NM from DER RWY 36L/R after take-off.
-------------------------------	----------------	--

GIMHAE 2 DEPARTURE
[GIMHA2]
(ALL RWYS)

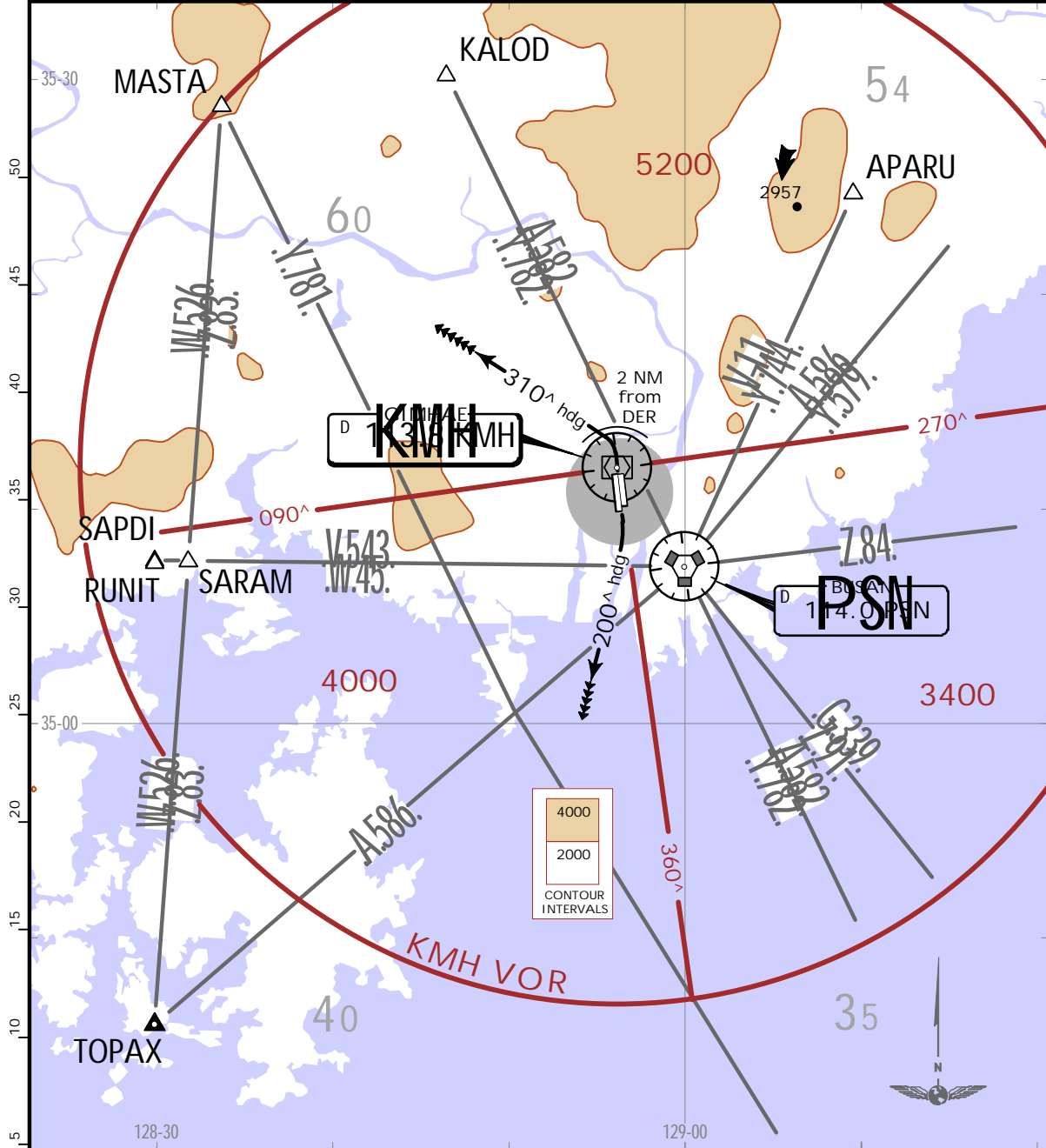

<p>LOST COMMS ▼ LOST COMMS ▼ LOST COMMS ▼ LOST COMMS</p> <p>▶ If radio contact is not established with departure control prior to reaching 5000, continue climb to 8000 before turning to filed fix/navaid and proceed filed route and altitude.</p> <p>LOST COMMS ▲ LOST COMMS ▲ LOST COMMS ▲ LOST COMMS ▲</p>	<p>Rwy 18L/R: Minimum climb rate of 360 per NM to 5000. Rwy 36L/R: Minimum climb rate of 500 per NM to 5000.</p> <table border="1"> <tr> <td>Gnd speed-KT</td> <td>75</td> <td>100</td> <td>150</td> <td>200</td> <td>250</td> <td>300</td> </tr> <tr> <td>360 per NM</td> <td>450</td> <td>600</td> <td>900</td> <td>1200</td> <td>1500</td> <td>1800</td> </tr> <tr> <td>500 per NM</td> <td>625</td> <td>833</td> <td>1250</td> <td>1667</td> <td>2083</td> <td>2500</td> </tr> </table>	Gnd speed-KT	75	100	150	200	250	300	360 per NM	450	600	900	1200	1500	1800	500 per NM	625	833	1250	1667	2083	2500
Gnd speed-KT	75	100	150	200	250	300																
360 per NM	450	600	900	1200	1500	1800																
500 per NM	625	833	1250	1667	2083	2500																

RWY	INITIAL CLIMB
18L/R	Climbing RIGHT turn heading 200°.
36L/R	Climbing LEFT turn heading 310°.

ROUTING

EXPECT RADAR vectors to intercept filed enroute fix or navaid. MAINTAIN 5000 or assigned altitude (flight level). EXPECT filed altitude/flight level 10 minutes after departure.

RKPK/PUS
GIMHAE INTL

JEPPESEN
31 MAR 23 (10-3E)

BUSAN, KOREA
.RNAV.SID.

GIMHAE Departure (R) 125.5	Apt Elev 13	Trans alt: 14000
		RNAV 1 required GNSS and RADAR required DME/DME/IRU not authorized
		All aircraft departing must complete turn within 2 NM from DER after takeoff.

OPONO 3 RNAV (GNSS) DEPARTURE
[OPONO3]
(RWYS 36L/R)

.SPEED: DO NOT EXCEED 230 KT UNTIL Opono

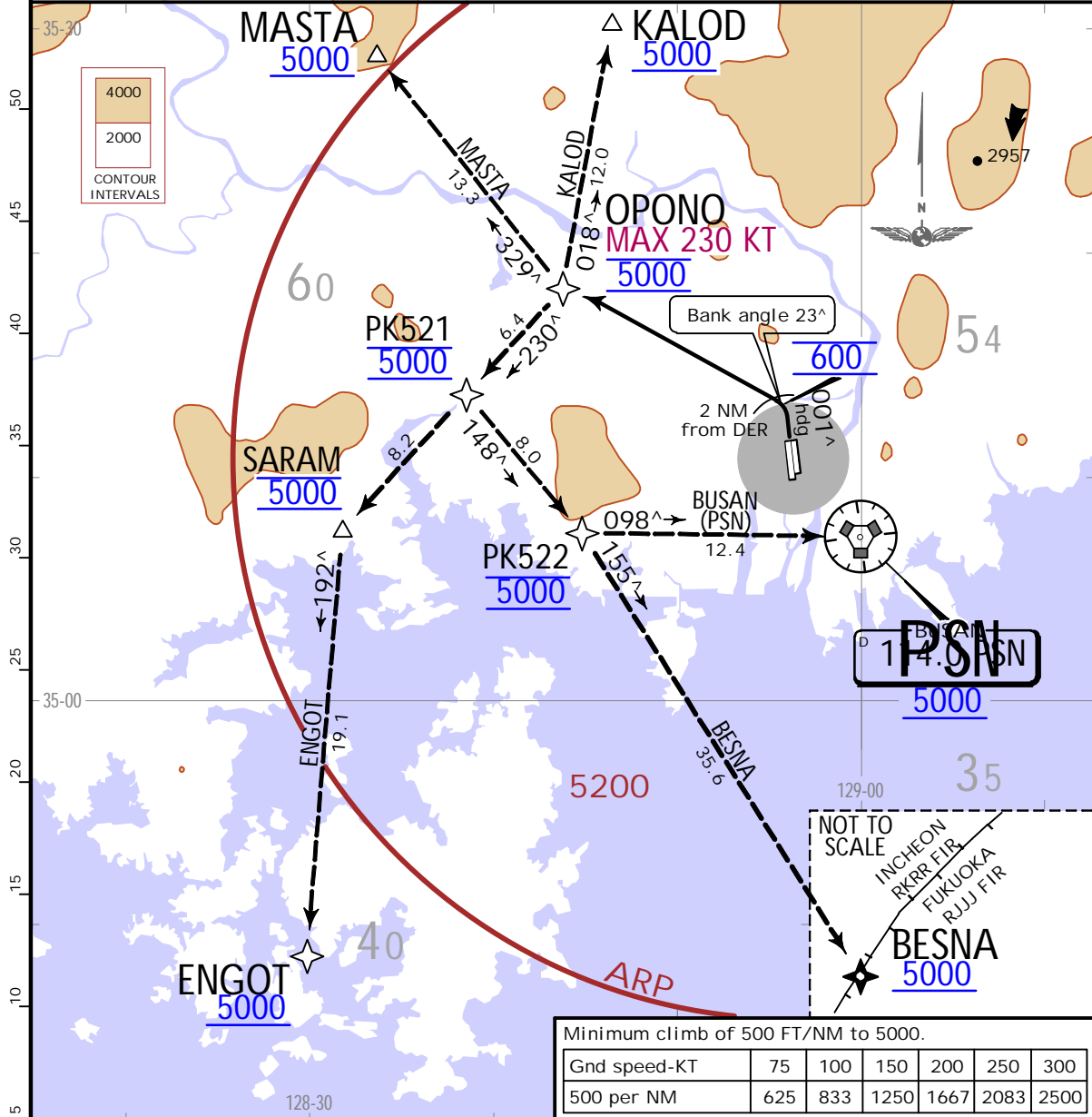

INITIAL CLIMB

Climb heading 001° to 600 then direct to cross Opono at 5000, then via transition and climb to altitude assigned by ATC.

TRANSITIONS

BESNA	At Opono on track 230° to cross PK521 at 5000, then on track 148° to cross PK522 at 5000, then on track 155° to BESNA.
BUSAN (PSN)	At Opono on track 230° to cross PK521 at 5000, then on track 148° to cross PK522 at 5000, then on track 098° to BUSAN (PSN VOR).
ENGOT	At Opono on track 230° to cross PK521 at 5000, then on track 230° to cross SARAM at 5000, then on track 192° to ENGOT.
KALOD	At Opono on track 018° to KALOD.
MASTA	At Opono on track 329° to MASTA.

RKPK/PUS
GIMHAE INTL

JEPPESSEN
3 FEB 23 (10-3F)

BUSAN, KOREA
.SID.

GIMHAE Departure (R) 125.5	Apt Elev 13	Trans alt: 14000 All aircraft departing must complete turn within 2 NM from DER after takeoff.
-------------------------------	----------------	---

SOORO 2 DEPARTURE
[SOORO2]
(RWYS 36L/R)

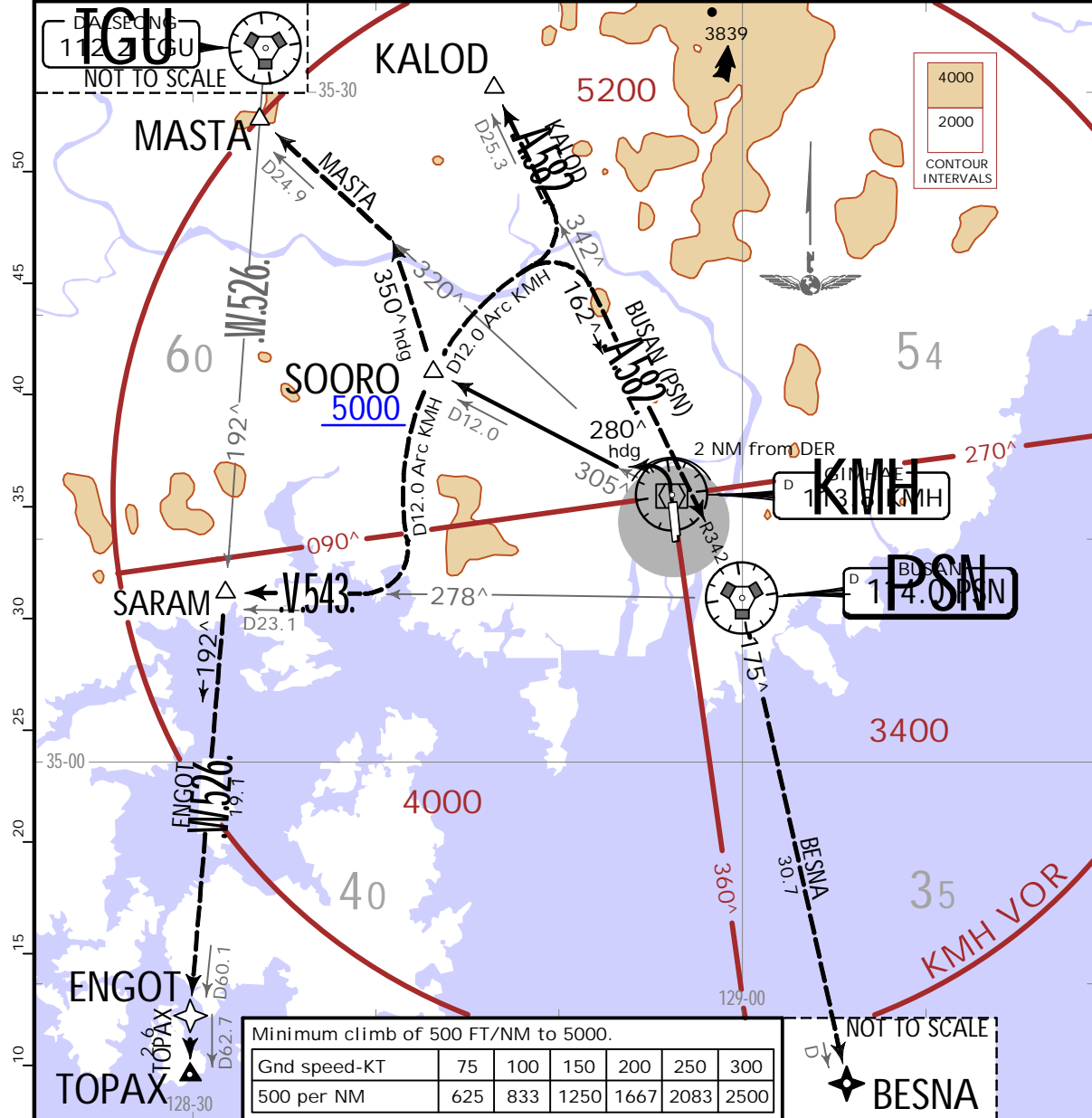

INITIAL CLIMB

Climbing LEFT turn as soon as practicable heading 280° to intercept KMH R305, then KMH R305 to cross SOORO at or above 5000. Then via transition, climb assigned altitude or as directed by ATC.

TRANSITIONS

BESNA	At SOORO, turn RIGHT and proceed via D12.0 Arc KMH to PSN R342, then via PSN R342 to PSN VOR, then via PSN R175 to BESNA.
BUSAN (PSN)	At SOORO, turn RIGHT and proceed via D12.0 Arc KMH to PSN R342 then via PSN R342 to PSN VOR.
ENGOT	At SOORO, turn LEFT and proceed via D12.0 Arc KMH to PSN R278, then via PSN R278 to SARAM, then LEFT turn via TGU R192 to ENGOT.
KALOD	At SOORO, turn RIGHT and proceed via D12.0 Arc KMH to PSN R342, then via PSN R342 to KALOD.
MASTA	At SOORO, turn RIGHT heading 350° to KMH R320, then KMH R320 to MASTA.
TOPAX	At SOORO, turn LEFT and proceed via D12.0 Arc KMH to PSN R278, then via PSN R278 to SARAM, then LEFT turn via TGU R192 to TOPAX.

CHANGES: Speed restriction note withdrawn.

RKPK/PUS
GIMHAE INTL

JEPESEN
3 FEB 23 **10-3G**

BUSAN, KOREA
.SID.

GIMHAE Departure (R) 125.5	Apt Elev 13	Trans alt: 14000 VOR/DME required.
-------------------------------	----------------	---------------------------------------

ULSUK 3 DEPARTURE
[ULSUK3]
(RWYS 18L/R)

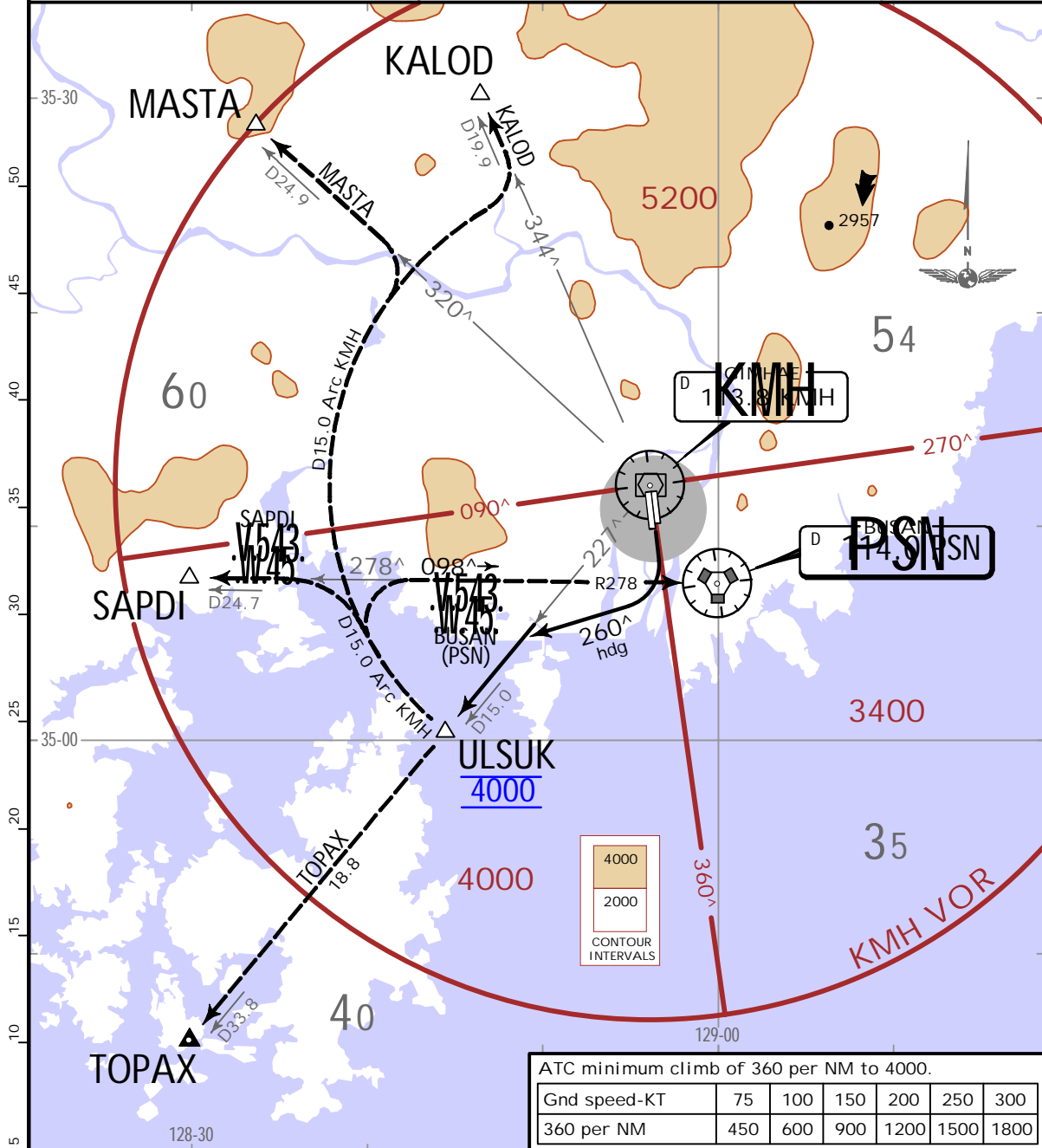

ATC minimum climb of 360 per NM to 4000.

Gnd speed-KT	75	100	150	200	250	300
360 per NM	450	600	900	1200	1500	1800

INITIAL CLIMB

Climbing RIGHT turn heading 260° to intercept KMH R227 and climb to 4000 on KMH R227 to ULSUK, then via transition, climb to assigned altitude or as directed by ATC.

TRANSITIONS

BUSAN (PSN)	At ULSUK, turn RIGHT and proceed via D15.0 Arc KMH to PSN R278, then via PSN R278 to BUSAN (PSN VOR).
KALOD	At ULSUK, turn RIGHT and proceed via D15.0 Arc KMH to KMH R344, then via KMH R344 to KALOD.
MASTA	At ULSUK, turn RIGHT and proceed via D15.0 Arc KMH to KMH R320, then via KMH R320 to MASTA.
SAPDI	At ULSUK, turn RIGHT and proceed via D15.0 Arc KMH to PSN R278, then via PSN R278 to SAPDI.
TOPAX	At ULSUK, KMH R227 to TOPAX.

NOISE ABATEMENT PROCEDURES

AIRCRAFT OPERATING PROCEDURES (Except Helicopters)

1. TAKE-OFF
 - A. NADP 1 (Rwy 36)
All departing aircraft should apply ICAO PANS-OPS (Doc 8168) Volume I Noise Abatement Departure Procedures One (NADP 1).
 - a. Thrust reduction at 1500' above airport elevation is recommended.
 - b. Whenever practicable, all departing aircraft should climb using the aircraft's certified maximum climb gradient until reaching 3000' AGL.
2. APPROACH

For noise abatement, using a delayed/reduced flap setting landing procedure is recommended. However use of this procedure is subject to the captain's decision and safety shall prevail at all times.

 - A. Delayed/Reduced Flap Setting Approach
All arriving aircraft shall apply the delayed/reduced flap setting approach as follows:
 - a. At IKHE/IKMA 9.0 DME, lower gear, and,
 - b. When making ILS Rwy 36R approach:
 - Maintain intermediate flap setting until passing IKHE 8.0 DME.
 - At IKHE 8.0 DME, set flaps for landing.
 - c. When making ILS Rwy 36L approach:
 - Maintain intermediate flap setting until passing IKMA 8.0 DME.
 - At IKMA 8.0 DME, set flaps for landing.
 - B. Circling Approach Rwy 18L/R (see Chart 10-4A)
When conducting a circling approach to land Rwy 18L/R, it is recommended that all aircraft avoid flying north of Namhae Expressway for noise abatement except for aircraft in an emergency or in an unavoidable situation, and helicopters.
 - C. Between 1200 UTC and 2200 UTC, pilots are requested to limit the use of reverse thrust to idle reverse after landing Rwy 36L except for operational or safety reasons.
3. EXEMPTIONS
 - A. Aircraft unable to comply with the procedures described in paragraphs 1. and 2. above, for any reason, should inform ATC.
 - B. Aircraft need not comply with the procedures described in paragraphs 1. and 2. above in adverse operating conditions, such as:
 - a. if the runway is not clear and dry, i.e., it is adversely affected by snow, slush, ice, water or other substances;
 - b. in conditions when the ceiling is lower than 500 feet, or when the horizontal visibility is less than 1.2 SM/1.9 km;
 - c. when the crosswind component, including gusts, exceeds 15 knots;
 - d. when the tailwind component, including gusts, exceeds 5 knots;
 - e. when wind shear has been reported or forecasted, or thunderstorms are expected to affect the approach.
4. RUNWAY OPERATION
 - A. Preferential Runway
For noise abatement, landing on or take-off from Rwy 36L is recommended.
 - B. Intersection Take-off
Rwy 18L/R intersection take-off is recommended except in unavoidable cases for traffic flow or other reasons.
5. OPERATIONAL LIMITATIONS
 - A. Engine Run-Up Tests
 - a. Engine start is permitted in the ramp areas only. However, power settings shall not exceed idle thrust.
 - B. Night Flight Restrictions (Curfew) for Noise Abatement
Take-offs and landings for all civil aircraft are restricted from 1400 to 2100 UTC. For a dispensation to be granted, the following criteria would need to be satisfied in exceptional circumstances for an aircraft to operate during the curfew. Any applications for dispensation will be considered for (b) and (d) between 1400 and 1430 UTC for the flight scheduled to depart from the airport before the start of the curfew period. (Local Time minus 9 hours = UTC):
 - a. aircraft undergoing an emergency situation (including illegal interference acts), or suspected of undergoing such a situation.
 - b. debarking of emergency patients in the aircraft departing from, or landing on the airport.
 - c. arriving or departing aircraft used in a national event.
 - d. re-screening of passengers and/or baggage for aviation security purposes.

RKPK/PUS

JEPPESEN

25 JUN 21 10-4A

NOISE
BUSAN, KOREA

GIMHAE INTL

NOISE ABATEMENT PROCEDURES

Do Not Fly North of Namhae Expressway

Namhae Expressway

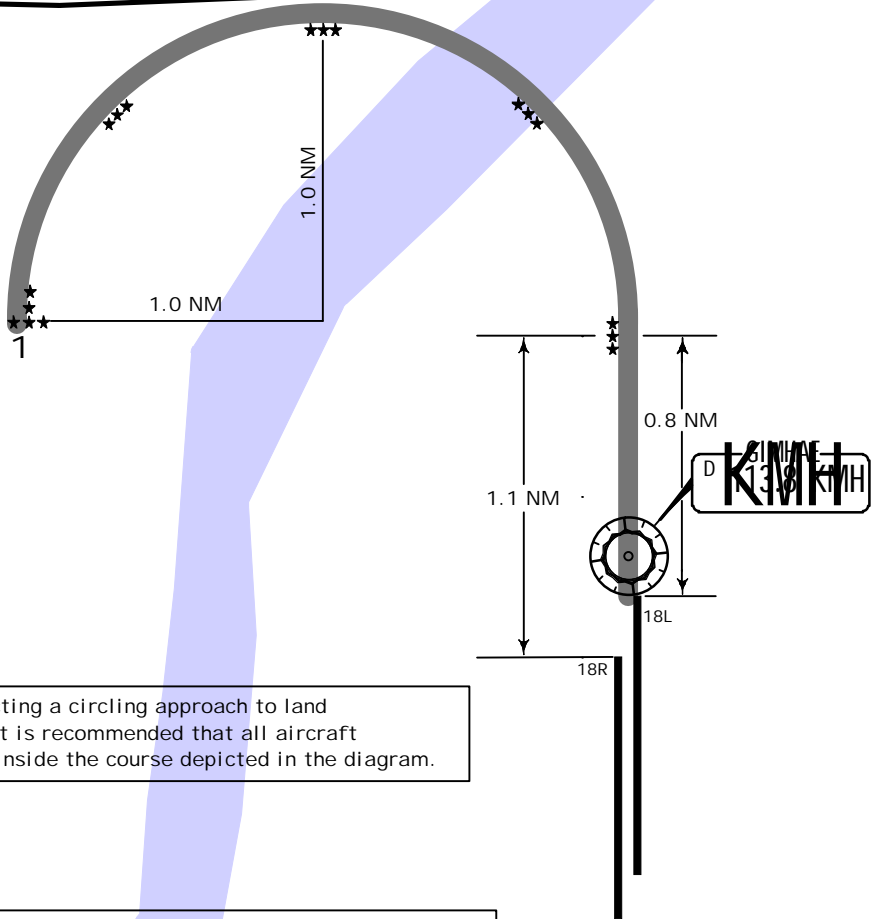

1 When conducting a circling approach to land Rwy 18L/R, it is recommended that all aircraft fly along or inside the course depicted in the diagram.

LEGEND

- *** Runway lead-in lighting system for Rwy 18L/R (Flashing White)
- Course along which aircraft fly for landing Rwy 18L/R
- Runway

RKPK/PUS

Apt Elev 13'
N35 10.8 E128 56.3

JEPPESEN

23 DEC 22 (10-9) .Eff. 31. Dec. 1500Z.

BUSAN, KOREA

GIMHAE INTL

*D-ATIS	ACARS D-ATIS PDC	GIMHAE Clearance	Apron	Ground	Tower	GIMHAE Departure
126.6		121.725 121.8	121.65	121.9	118.1 118.45	125.5

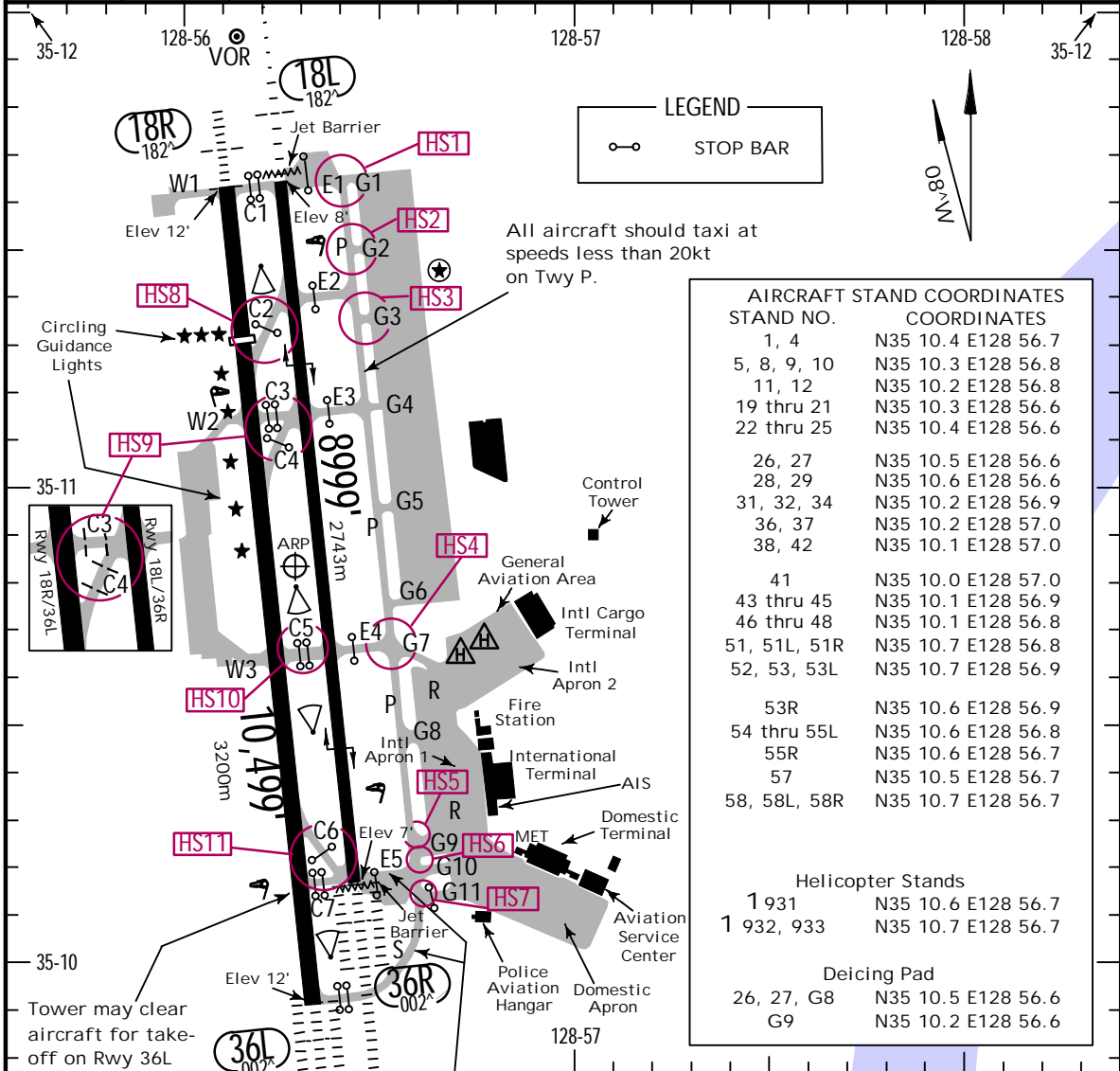

AIRCRAFT STAND NO.	COORDINATES
1, 4	N35 10.4 E128 56.7
5, 8, 9, 10	N35 10.3 E128 56.8
11, 12	N35 10.2 E128 56.8
19 thru 21	N35 10.3 E128 56.6
22 thru 25	N35 10.4 E128 56.6
26, 27	N35 10.5 E128 56.6
28, 29	N35 10.6 E128 56.6
31, 32, 34	N35 10.2 E128 56.9
36, 37	N35 10.2 E128 57.0
38, 42	N35 10.1 E128 57.0
41	N35 10.0 E128 57.0
43 thru 45	N35 10.1 E128 56.9
46 thru 48	N35 10.1 E128 56.8
51, 51L, 51R	N35 10.7 E128 56.8
52, 53, 53L	N35 10.7 E128 56.9
53R	N35 10.6 E128 56.9
54 thru 55L	N35 10.6 E128 56.8
55R	N35 10.6 E128 56.7
57	N35 10.5 E128 56.7
58, 58L, 58R	N35 10.7 E128 56.7

Helicopter Stands	COORDINATES
1 931	N35 10.6 E128 56.7
1 932, 933	N35 10.7 E128 56.7

Deicing Pad	COORDINATES
26, 27, G8	N35 10.5 E128 56.6
G9	N35 10.2 E128 56.6

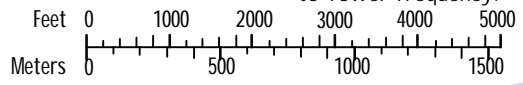
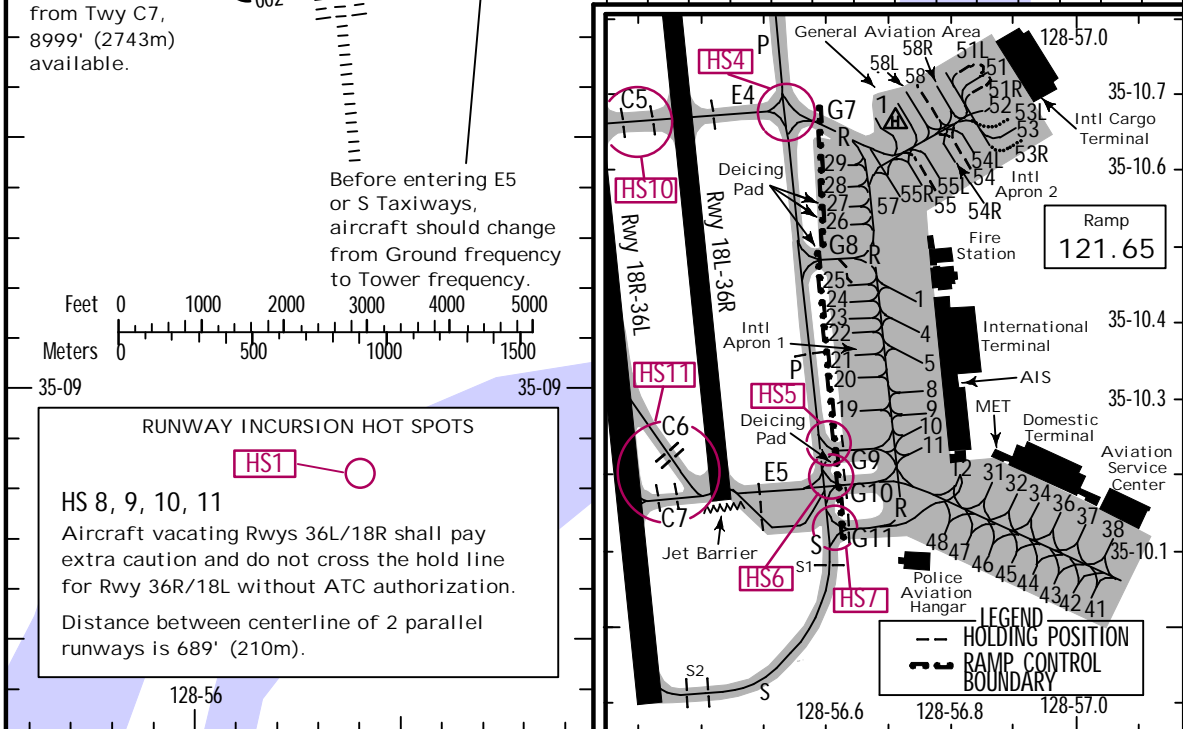

RUNWAY INCURSION HOT SPOTS

HS1

HS 8, 9, 10, 11

Aircraft vacating Rws 36L/18R shall pay extra caution and do not cross the hold line for Rwy 36R/18L without ATC authorization.

Distance between centerline of 2 parallel runways is 689' (210m).

RKPK/PUS



BUSAN, KOREA

23 DEC 22

10-9A

.Eff.31.Dec.1500Z.

GIMHAE INTL

GENERAL:
 CAUTION: Mountainous area north of the airport.
 Operational hours for civil aircraft daily from 2100Z-1400Z.
 Birds in vicinity of airport.

ADDITIONAL RUNWAY INFORMATION

RWY		USABLE LENGTHS			WIDTH
		Threshold	LANDING BEYOND Glide Slope	TAKE-OFF	
18L	HIRL (30m) CL(15m) SSALR REIL 3 PAPI (angle 3.0^) Lead-in Lights				151' 46m
1 2 36R	HIRL (30m) CL(15m) ALSF-II TDZ PAPI-L (angle 3.0^) RVR		7905' 2409m		

- 1 Grooved.
- 2 All lighting systems for Rwy 18L/36R will be available only when requested by a pilot.
- 3 Unserviceable beyond 2 NM from PAPI location due to terrain.

18R 4	HIRL (30m) CL(15m) SSALF REIL 5 PAPI (angle 3.0^) Lead-in Lights Circling guidance lights	8530' 2600m			197' 60m
6 36L	HIRL (30m) CL(15m) ALSF-II TDZ PAPI-L (angle 3.0^) RVR		9430' 2874m		

- 4 Grooved except 984' (300m) inward from Rwy 18R threshold.
- 5 Unserviceable beyond 2 NM from PAPI location due to terrain. PAPI-R offset 12^ to the west.
- 6 Grooved except 312' (95m) inward from Rwy 36L threshold.

TAKE-OFF

All Rwys

All Acft	100' - 350m
----------	-------------

FOR FILING AS ALTERNATE

	Precision	Non-Precision
A	600'-3200m	800'-3200m
B		
C		1100'-4800m
D		

RKPK/PUS

GIMHAE INTL

JEPPESEN

3 MAR 23 10-9B

SMGCS
BUSAN, KOREA

LOW VISIBILITY TAXI ROUTES

Rwy. 36L ARRIVAL

.LESS THAN RVR. 550m.

*D-ATIS	ACARS: D-ATIS PDC	GIMHAE Clearance		Apron	Ground	Tower		GIMHAE Departure
126.6		121.725	121.8	121.65	121.9	118.1	118.45	125.5

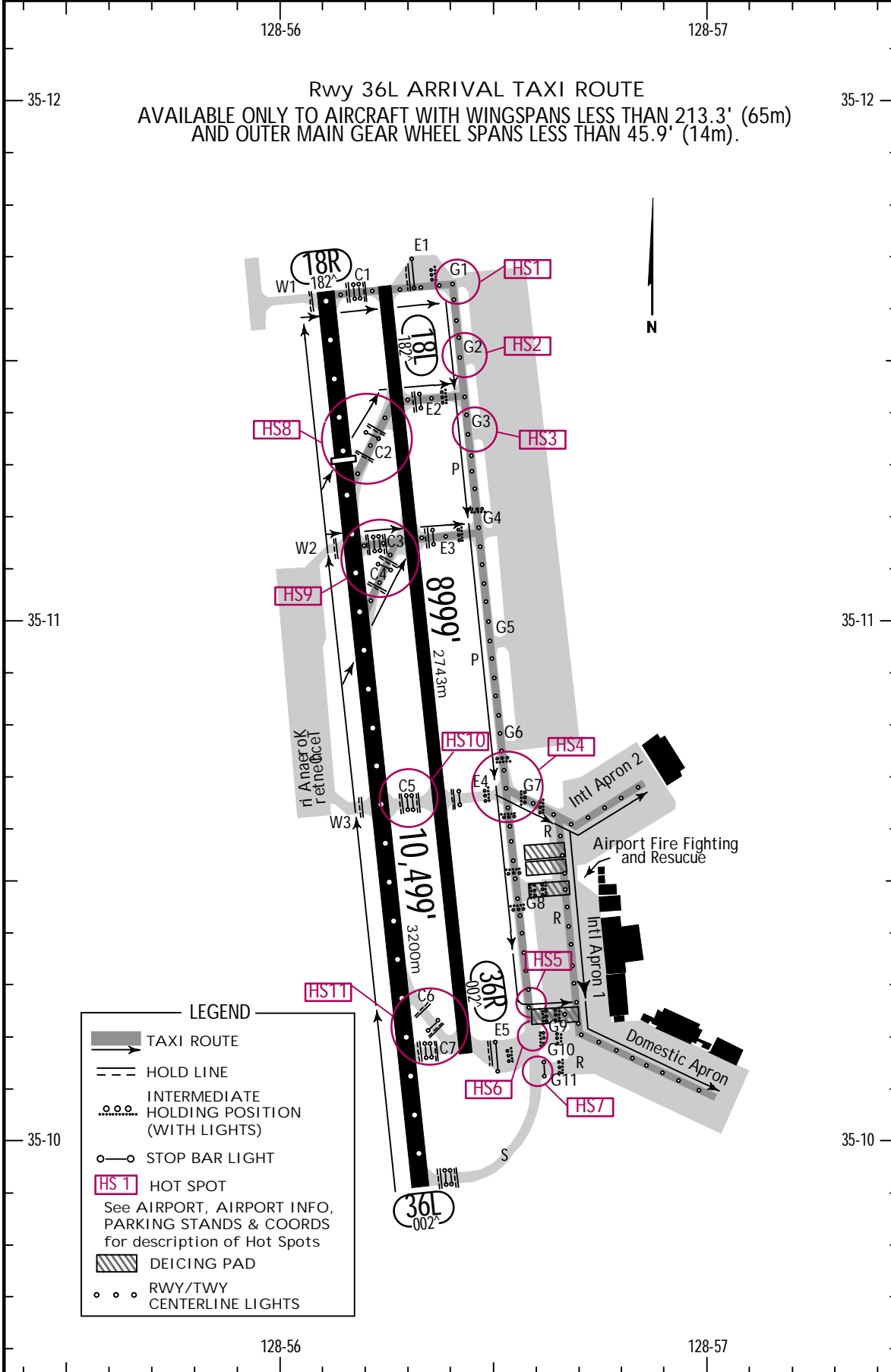

RKPK/PUS

GIMHAE INTL



3 MAR 23

10-9C

SMGCS
BUSAN, KOREA

LOW VISIBILITY TAXI ROUTES

Rwy. 36L DEPARTURE

.LESS THAN RVR.550m.

*D-ATIS	ACARS: D-ATIS PDC	GIMHAE Clearance		Apron	Ground	Tower		GIMHAE Departure
126.6		121.725	121.8	121.65	121.9	118.1	118.45	125.5

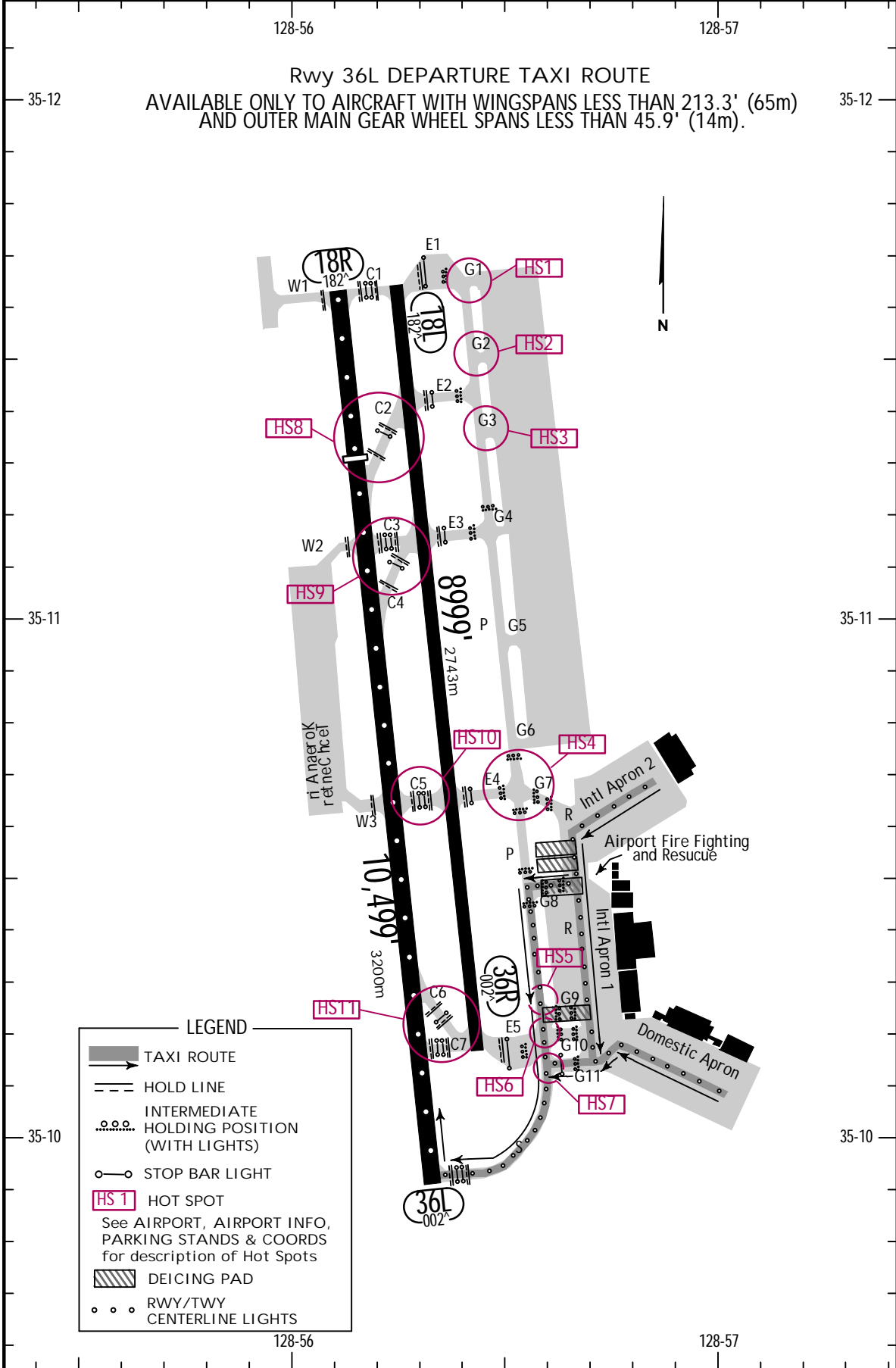

RKPK/PUS

JEPPESEN

GIMHAE INTL

3 MAR 23

10-9D

SMGCS.
BUSAN, KOREA

LOW VISIBILITY TAXI ROUTES

Rwy. 36R DEPARTURE.

.LESS THAN RVR.550m.

*D-ATIS	ACARS: D-ATIS PDC	GIMHAE Clearance		Apron	Ground	Tower		GIMHAE Departure
126.6		121.725	121.8	121.65	121.9	118.1	118.45	125.5

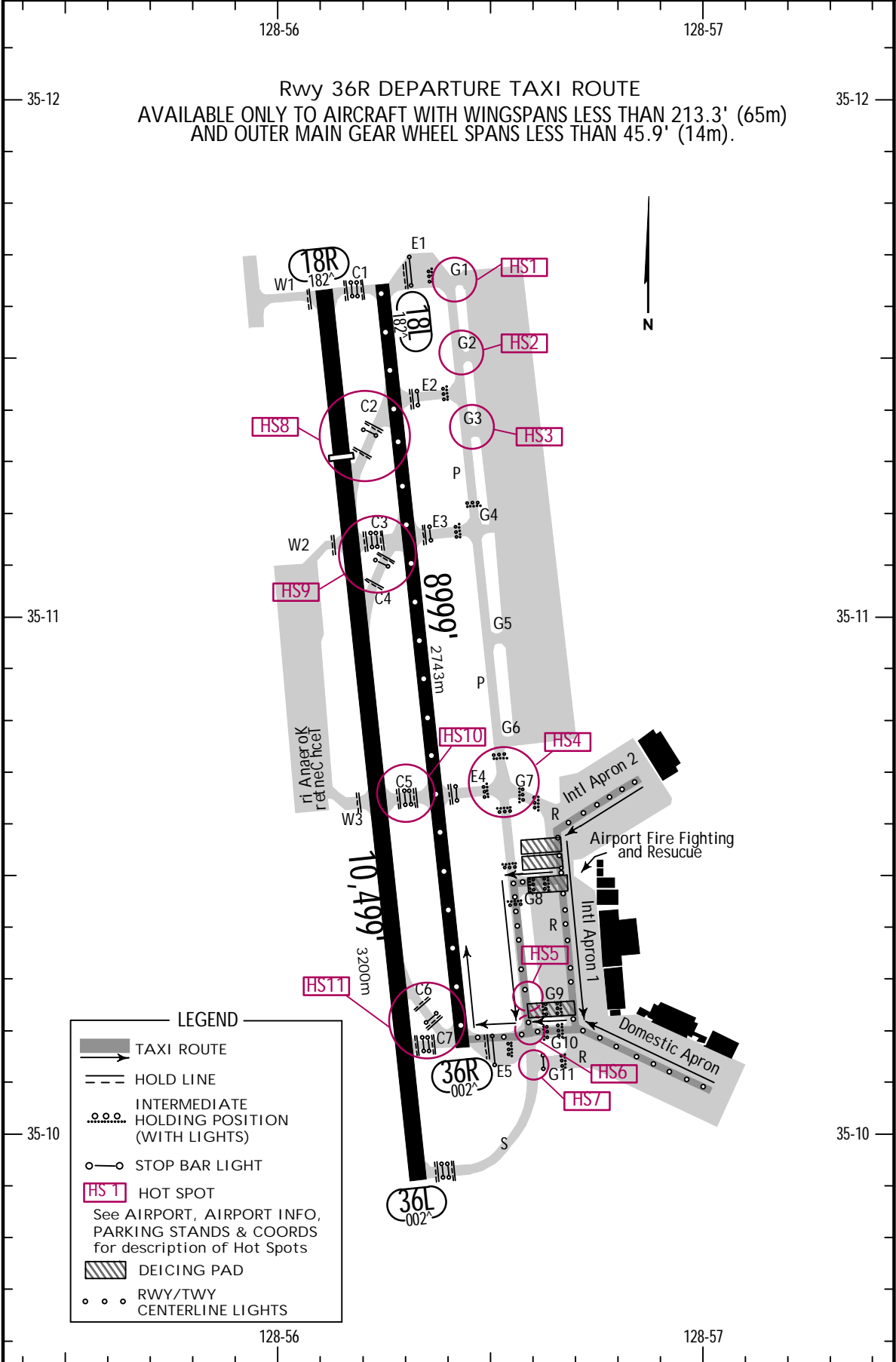

RKPK/PUS

JEPESEN

GIMHAE INTL

3 MAR 23 10-9E

SMGCS
BUSAN, KOREA

LOW VISIBILITY TAXI ROUTES

.LESS THAN RVR.550m.

.Rwy.18L/R.DEPARTURE.

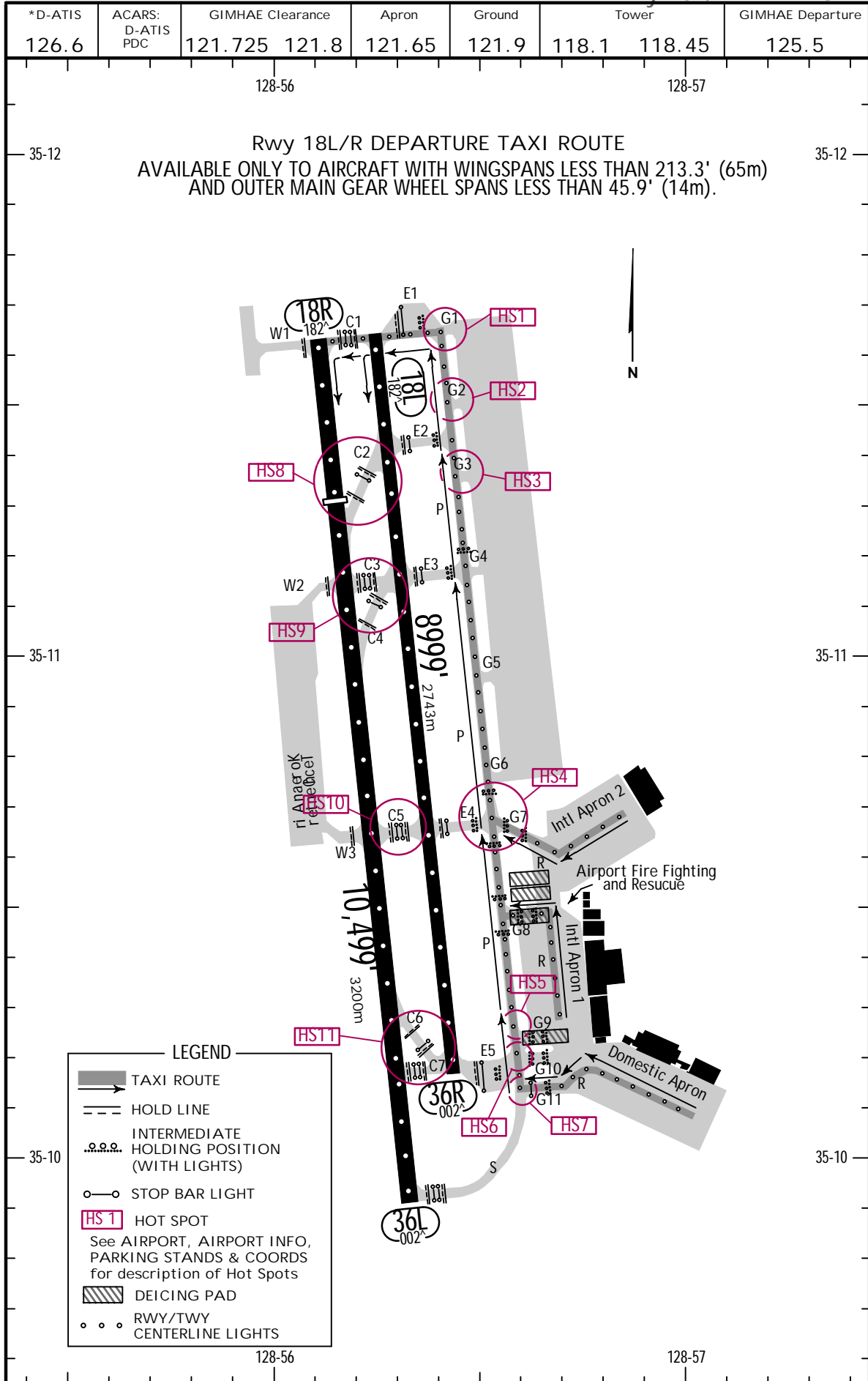

RKPK/PUS
GIMHAE INTL

JEPESEN

9 JUL 21 (11-1) .Eff. 14 Jul. 1600Z.

BUSAN, KOREA
ILS Y Rwy 36L

*D-ATIS 126.6	GIMHAE Arrival 119.2 134.4		GIMHAE Approach (R) 125.5	GIMHAE Tower 118.1 118.45	Ground 121.9
LOC IKMA 108.5	Final Apch Crs 001 [^]	D6.6 IKMA 2100' (2087')	ILS DA(H) 213' (200')	Apt Elev 13'	TDZE 13'
MISSED APCH: Climb to 500', then LEFT turn heading 310 [^] to intercept KMH VOR R-310, then KMH VOR R-310 to D15.0 KMH and 6000', then 15 DME Arc KMH VOR to GEOJE and hold. Missed Approach requires minimum climb of 370' /NM to 6000'.					
Alt set: hPa TDZ Elev: 0 hPa Trans level: FL 140 Trans alt: 14000'					
1. VOR DME or Radar required. 2. Circling is not authorized. 3. Use IKMA DME when on the localizer course. 4. VGSI and ILS glidepath not coincident (VGSI angle 3.00 [^] TCH 67').					

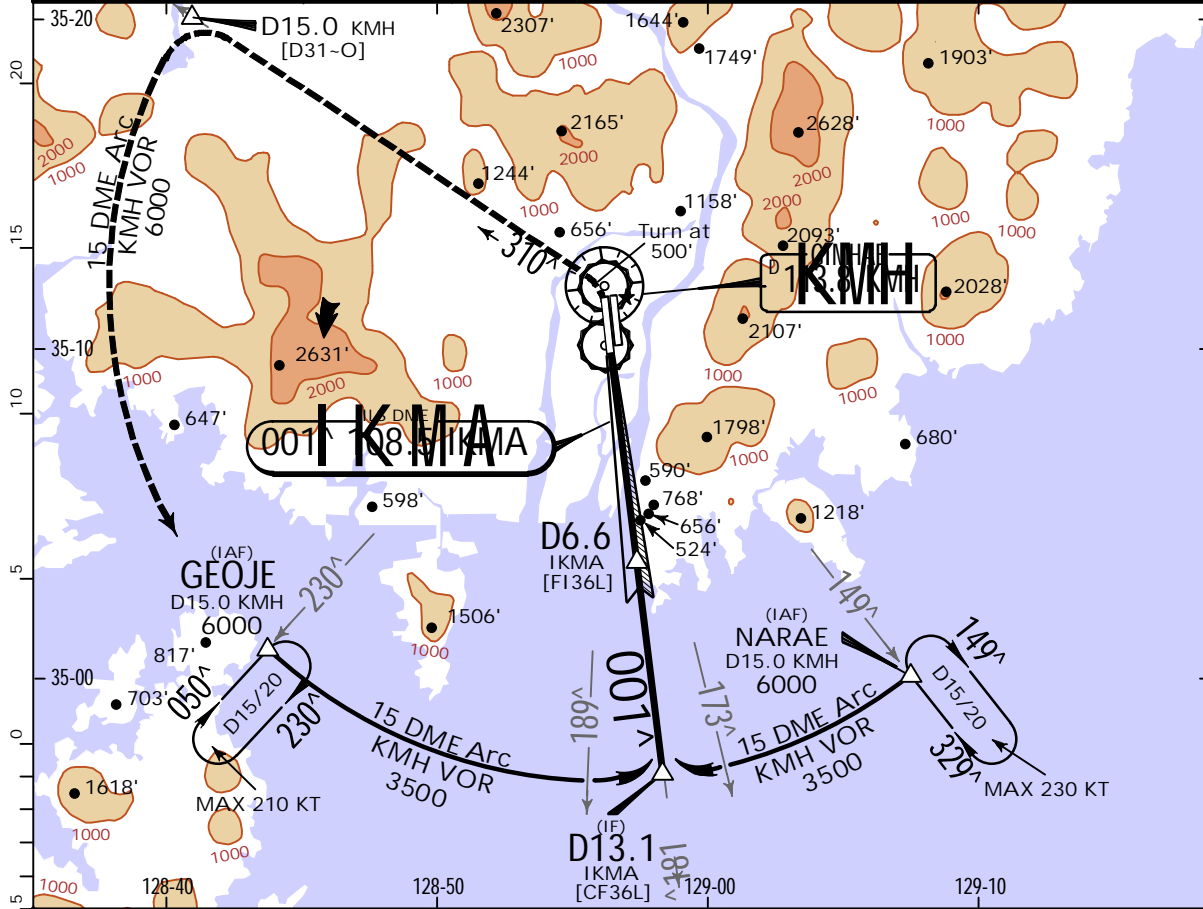

D6.6 IKMA [F136L] GS 2100'		D13.1 IKMA [CF36L] GS 3500'	
TCH 57'		TDZE 13'	
6.4		6.5	

Gnd speed-Kts	70	90	100	120	140	160	ALSF-II	500'	6000'	KMH 113.8	D15.0 KMH
GS	3.00 [^]	372	478	531	637	849					

STRAIGHT-IN LANDING RWY 36L .CEILING REQUIRED.
ILS DA(H) 213' (200')

	FULL	TDZ/CL out CEIL-VIS	ALS out
A	200' - RVR 18 or 1/2	200' - RVR 24 or 1/2	200' - RVR 40 or 3/4
B	200' - 1 RVR 24 or 1/2		
C			
D			

RKPK/PUS
GIMHAE INTL

JEPPESSEN
9 JUL 21 (11-2) .Eff.14.Jul.1600Z.

BUSAN, KOREA
ILS Z Rwy 36L

*D-ATIS 126.6	GIMHAE Arrival 119.2 134.4	GIMHAE Approach (R) 125.5	GIMHAE Tower 118.1 118.45	Ground 121.9
LOC IKMA 108.5	Final Apch Crs 001 [^]	OLMOG 2100' (2087')	ILS DA(H) 213' (200')	Apt Elev 13' TDZE 13'
MISSED APCH: Climb to 500', then climbing LEFT to 6000' direct Opono, then track 231 [^] to GAYHA, then track 166 [^] to KEVOX and hold. Missed Apch requires minimum climb of 370' /NM to 6000'.				5200 MSA ARP
Alt set: hPa TDZ Elev: 0 hPa Trans level: FL 140 Trans alt: 14000'				
1. GNSS and Radar required. 2. RNAV 1.0 required. 3. Circling is not authorized. 4. Approach limited to MAX 230 KT and missed approach to MAX 210 KT. 5. VGSI and ILS glidepath not coincident (VGSI angle 3.00 [^] TCH 67'). 6. Use IKMA DME when on the localizer course.				

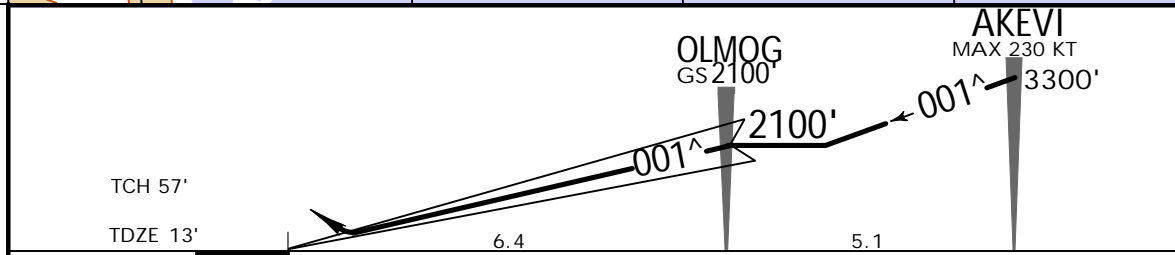
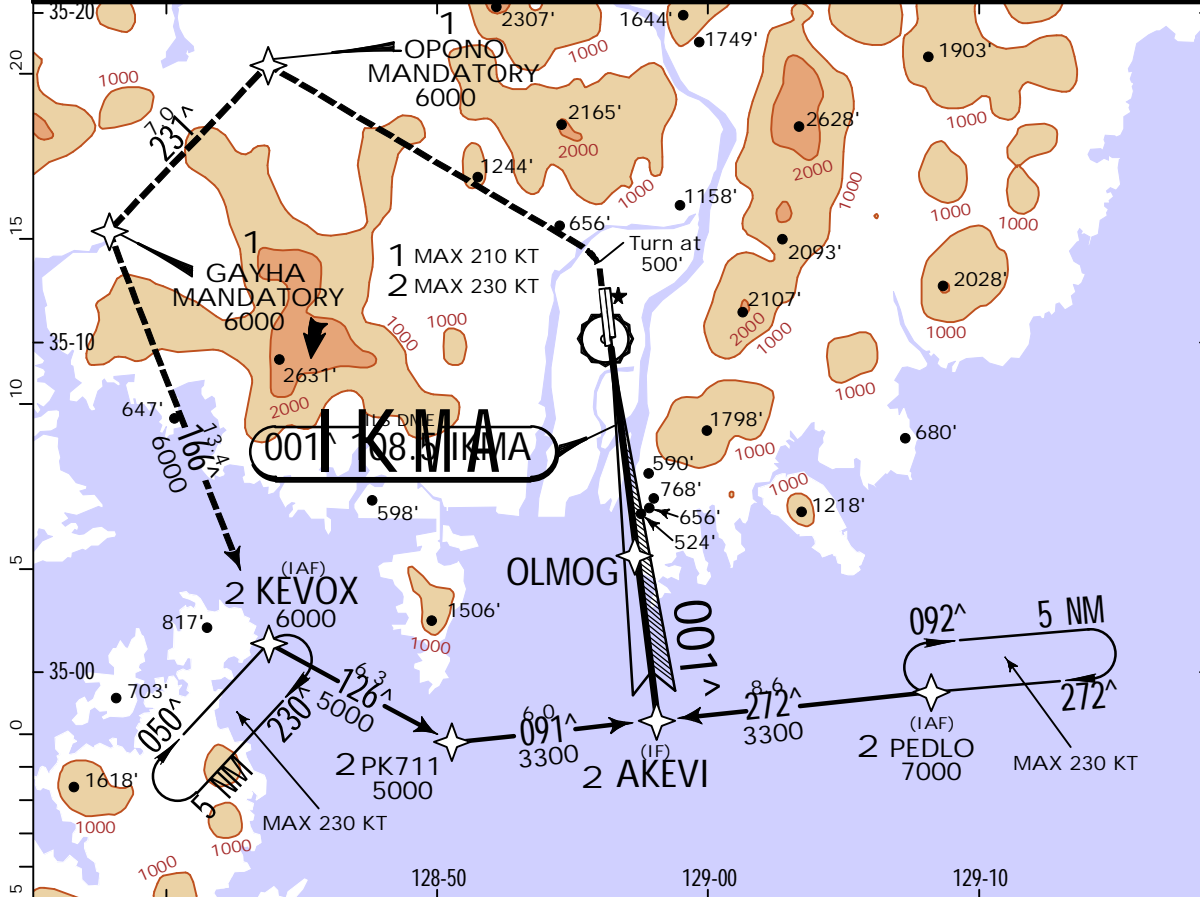

Gnd speed-Kts	70	90	100	120	140	160
Gs	3.00 [^]	372	478	531	637	849

STRAIGHT-IN LANDING RWY 36L .CEILING.REQUIRED.
 ILS DA(H) 213' (200')
 FULL TDZ/CL out ALS out

A			
B			
C	200' - RVR 18 or 1/2	200' - RVR 24 or 1/2	200' - RVR 40 or 3/4
D			

RKPK/PUS GIMHAE INTL

JEPPESSEN
9 JUL 21 (11-3) .Eff.14.Jul.1600Z.

BUSAN, KOREA ILS Y Rwy 36R

*D-ATIS 126.6	GIMHAE Arrival 119.2 134.4	GIMHAE Approach (R) 125.5	GIMHAE Tower 118.1 118.45	Ground 121.9
LOC IKHE 109.5	Final Apch Crs 001 [^]	D6.6 IKHE 2100' (2092')	ILS DA(H) 208' (200')	Apt Elev 13' TDZE 8'
BRIEFING STRIP™ MISSED APCH: Climb to 6000' via LEFT turn and track outbound on KMH VOR R-310 to D15.0 KMH, then direct to GEOJE (when radar inop, track KMH VOR D15.0 Arc to GEOJE) and hold or as directed by ATC. CAUTION: Missed Approach requires minimum climb rate of 400' /NM to 6000'.				MSA KMH VOR
Alt set: hPa		TDZ Elev: 0 hPa	Trans level: FL 140	
1. VOR/DME or Radar required. 2. EMERGENCY SAFE ALTITUDE WITHIN 100 NM 8400'. 3. VGSI and ILS glidepath not coincident (VGSI Angle 3.00 [^] TCH 75'). 4. Use IKHE DME when on the localizer course. 5. Circling is not authorized.				

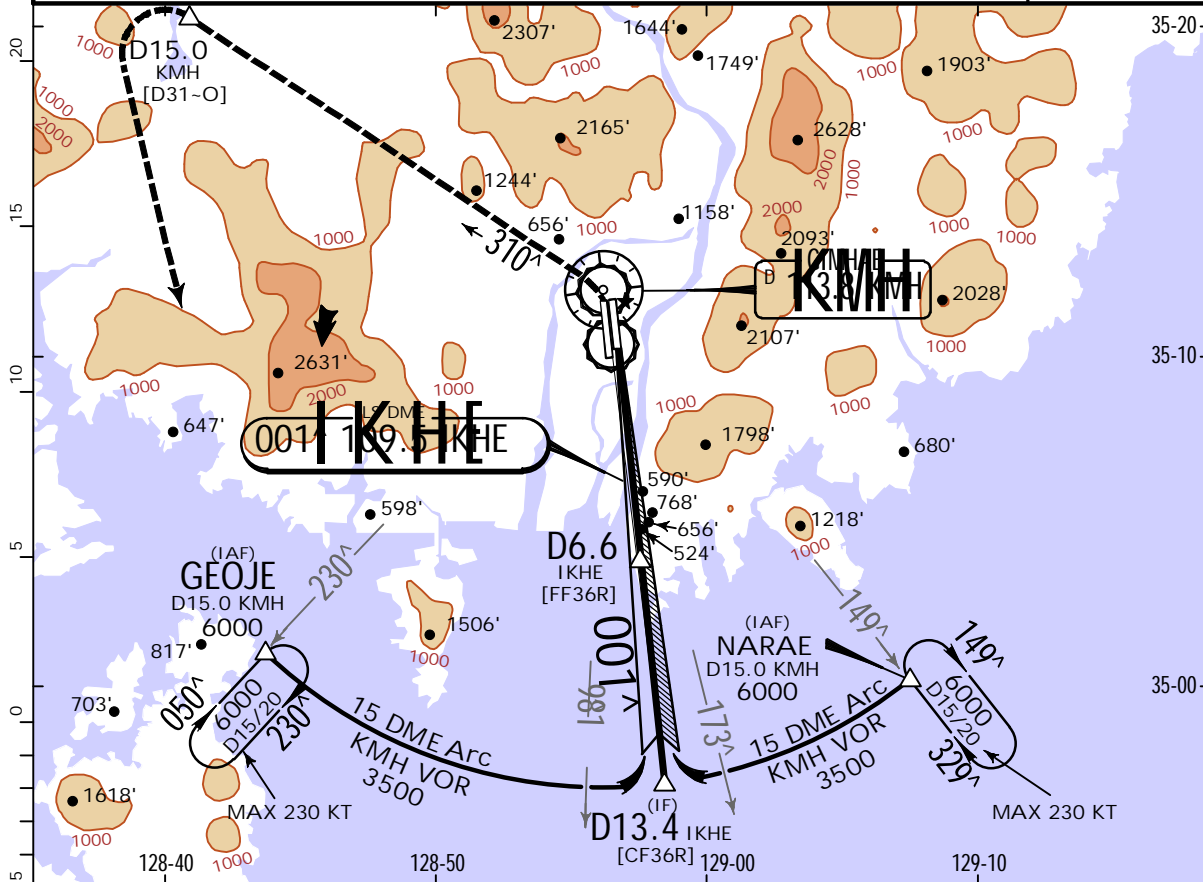

D6.6 IKHE [FF36R] GS 2100'	D13.4 IKHE [CF36R]
TCH 56'	TDZE 8'
6.4	6.8

Gnd speed-Kts	70	90	100	120	140	160	ALSF-II	6000'	KMH	D15.0
Descent Angle	3.00 [^]	372	478	531	637	849	PAPI	via	113.8	KMH
								LT	R-310	

STRAIGHT-IN LANDING RWY 36R .CEILING REQUIRED.		
ILS DA(H) 208' (200')		
FULL	TDZ/CL out CEIL-VIS	ALS out
A	200' - RVR 18 or 1/2	
B		200' - RVR 40 or 3/4
C	200' - 1 RVR 24 or 1/2	
D		
1 RVR 18 Civil Use Only		

RKPK/PUS
GIMHAE INTL



9 JUL 21

(11-5)

Eff. 14 Jul 1600Z

BUSAN, KOREA
LOC DME Y Rwy 36L

*D-ATIS 126.6	GIMHAE Arrival 119.2 134.4		GIMHAE Approach (R) 125.5		GIMHAE Tower 118.1 118.45		Ground 121.9
LOC IKMA 108.5	Final Apch Crs 001 [^]	D6.6 IKMA 2100' (2088')	MDA(H) 400' (388')	Apt Elev 13' Rwy 12'			
MISSED APCH: Climb to 700', then LEFT turn climbing 6000' on KMH VOR R-310 to D15.0 KMH, then 15 DME Arc KMH VOR to GEOJE and hold. Missed Approach requires minimum climb of 360' /NM to 6000'.							MSA KMH VOR
Alt set: hPa		TDZ Elev: 0 hPa	Trans level: FL 140		Trans alt: 14000'		
1. VOR DME or Radar required. 2. Use IKMA DME when on the localizer course.							

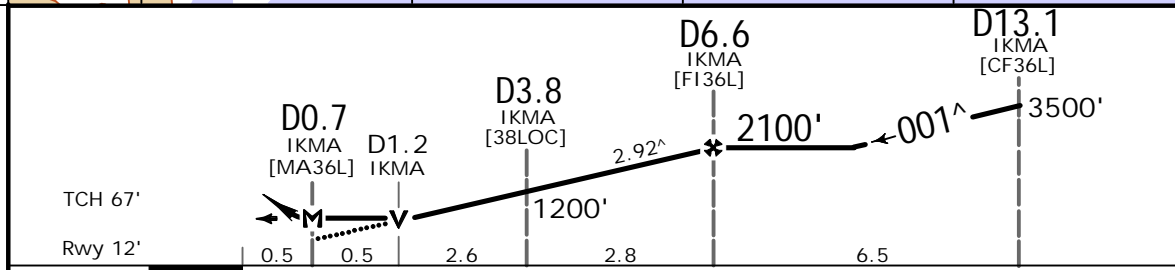
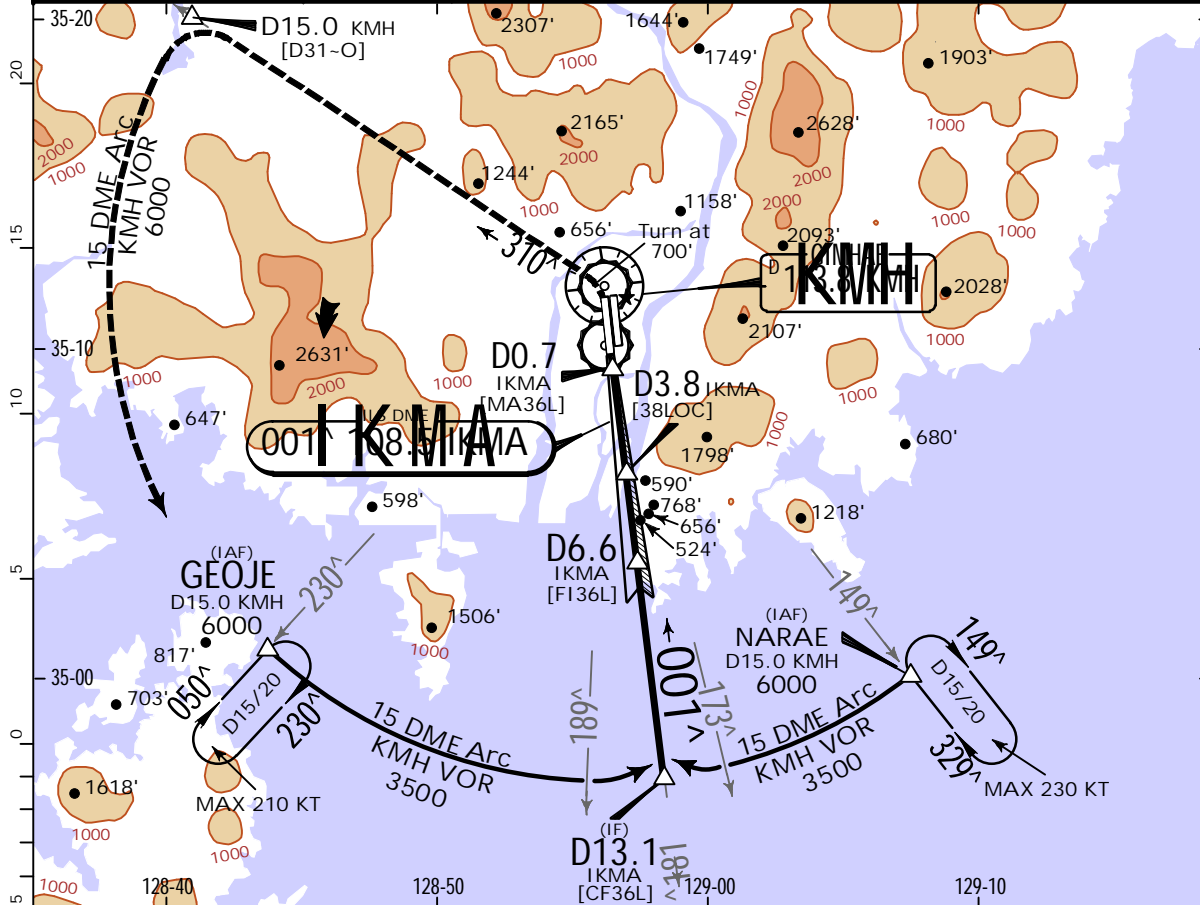

Gnd speed-Kts	70	90	100	120	140	160	ALSF-II 	700'	6000'	KMH	D15.0
Descent Angle	2.92 [^]	362	465	517	620	826		↑	←	on R-310	KMH
MAP at D0.7 IKMA											

TERPS	STRAIGHT-IN LANDING RWY36L		CEILING REQUIRED		CIRCLE-TO-LAND		
	LOC (GS out)				Not Authorized East of Rwy 18/36		
	MDA(H) 400' (388')						
	CEIL-VIS		ALS out		Max Kts	MDA(H)	CEIL-VIS
	A	400' - RVR 24 or 1/2	400' - RVR 55 or 1		90	520' (507')	600' - 1
B				120	580' (567')	600' - 1	
C				140	1360' (1347')	1400' - 3	
D	400' - RVR 35 or 5/8	400' - RVR 60 or 1 1/8		165	1700' (1687')	1700' - 3	

CHANGES: None.

JEPPesen, 2017, 2021. ALL RIGHTS RESERVED.

RKPK/PUS
GIMHAE INTL

JEPPESSEN
9 JUL 21
Eff. 14 Jul. 1600Z. (11-6)

BUSAN, KOREA
LOC DME Z Rwy 36L

*D-ATIS 126.6	GIMHAE Arrival 119.2 134.4	GIMHAE Approach (R) 125.5	GIMHAE Tower 118.1 118.45	Ground 121.9
LOC IKMA 108.5	Final Apch Crs 001 [^]	OLMOG 2100' (2088')	MDA(H) 400' (388')	Apt Elev 13' Rwy 12'
MISSED APCH: Climb to 700', then climbing LEFT to 6000' direct Opono, then track 231 [^] to GAYHA, then track 166 [^] to KEVOX and hold. Missed Apch requires minimum climb of 360' /NM to 6000'.				5200 MSA ARP
Alt set: hPa TDZ Elev: 0 hPa Trans level: FL 140 Trans alt: 14000'				
1. GNSS and Radar required. 2. RNAV 1.0 required. 3. Approach limited to MAX 230 KT and missed approach to MAX 210 KT. 4. Use IKMA DME when on the localizer course.				

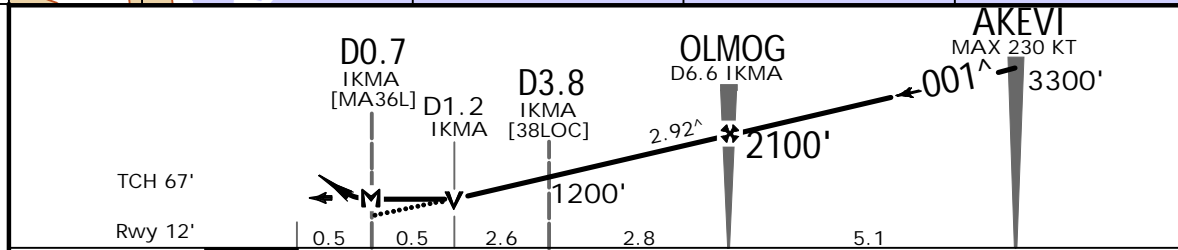
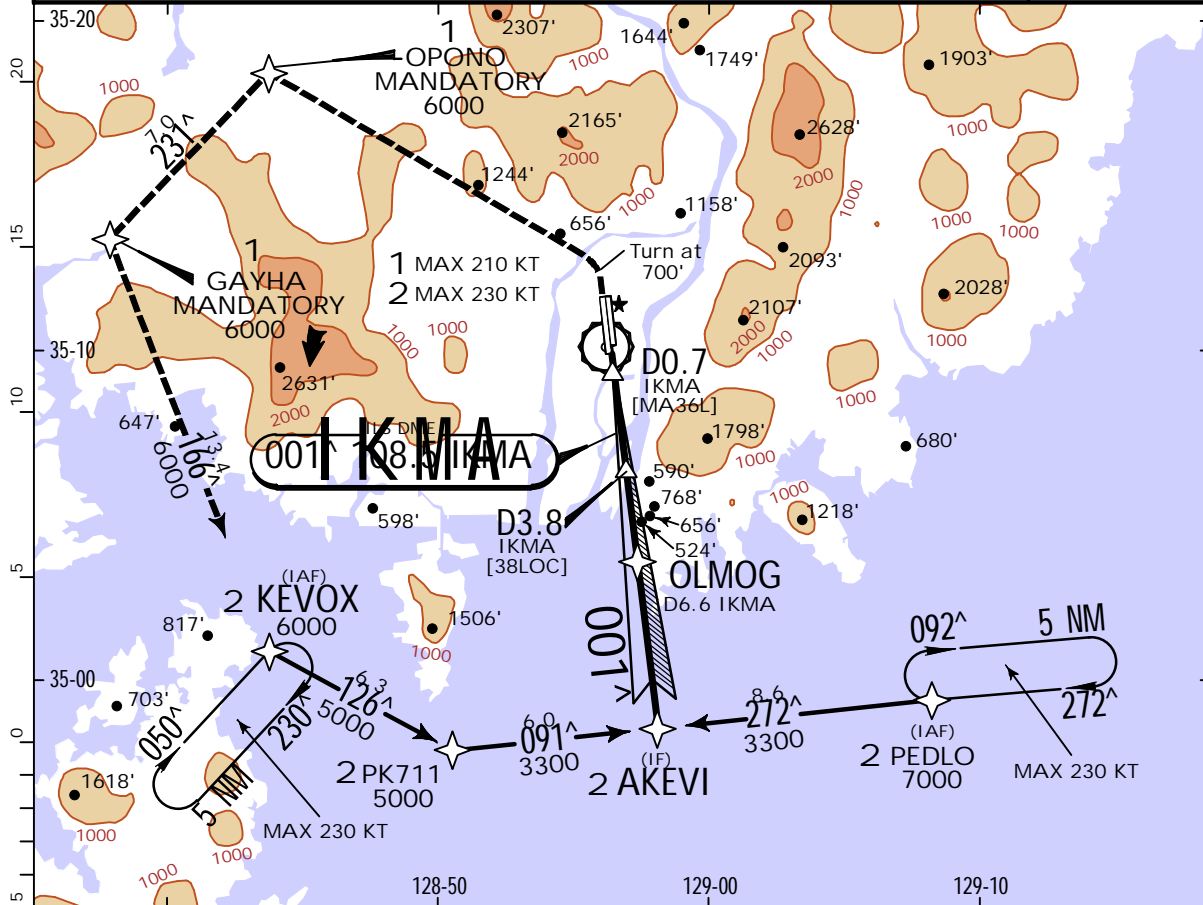

Gnd speed-Kts	70	90	100	120	140	160
Descent Angle	2.92 [^]	362	465	517	620	826

MAP at D0.7 IKMA STRAIGHT-IN LANDING RWY36L .CEILING REQUIRED. CIRCLE-TO-LAND

LOC (GS out)		MDA(H) 400' (388')		Not Authorized East of Rwy 18/36	
CEIL-VIS		ALS out		Max Kts	MDA(H) CEIL-VIS
A	400' - RVR 24 or 1/2	400'	RVR 55 or 1	90	520' (507') 600' - 1
B				120	580' (567') 600' - 1
C	400' - RVR 35 or 5/8	400'	RVR 60 or 1/8	140	1360' (1347') 1400' - 3
D				165	1700' (1687') 1700' - 3

CHANGES: Waypoints identis.

JEPPESSEN, 2017, 2021. ALL RIGHTS RESERVED.

RKPK/PUS
GIMHAE INTL

JEPPESSEN

23 JUL 21 (11-7)

BUSAN, KOREA
LOC DME Y Rwy 36R

*D-ATIS 126.6	GIMHAE Arrival 119.2 134.4	GIMHAE Approach (R) 125.5	GIMHAE Tower 118.1 118.45	Ground 121.9
LOC IKHE 109.5	Final Apch Crs 001 [^]	D6.6 IKHE 2100' (2093')	MDA(H) 420' (413')	Apt Elev 13' Rwy 7'
MISSED APCH: Climb to 6000' via LEFT turn and track outbound on KMH VOR R-310 to D15.0 KMH, then direct to GEOJE (when radar inop, track KMH VOR D15.0 Arc to GEOJE) and hold or as directed by ATC. CAUTION: Missed Apch requires minimum climb rate of 350'/NM to 6000'.				
Alt set: hPa		TDZ Elev: 0 hPa	Trans level: FL 140	
1. VOR/DME or Radar required. 2. EMERGENCY SAFE ALTITUDE WITHIN 100 NM 8400'. 3. Use IKHE DME when on the localizer course.				MSA KMH VOR

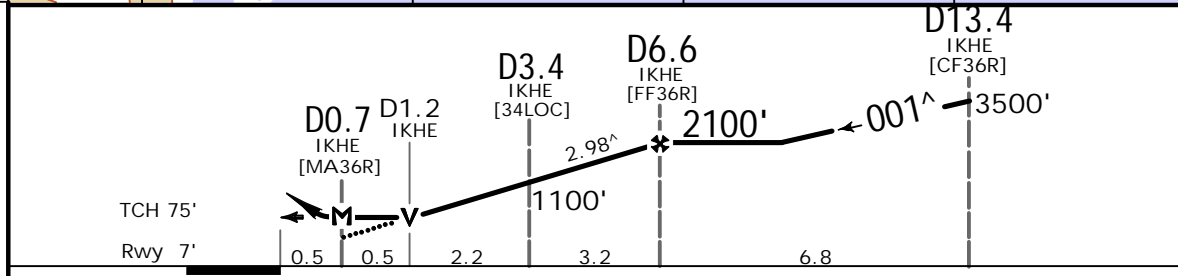
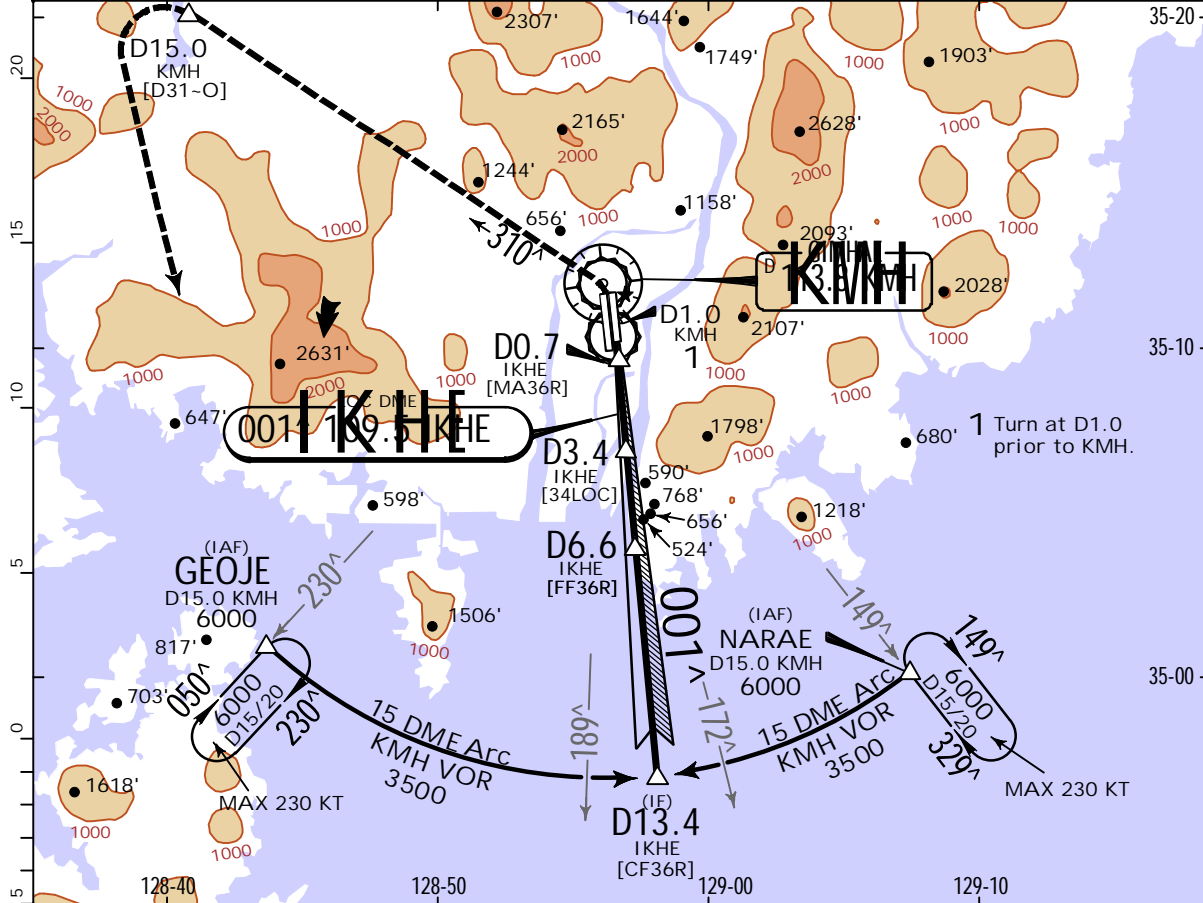

Gnd speed-Kts	70	90	100	120	140	160	ALSF-II PAPI	6000' via 113.8 R-310 LT	D15.0 KMH
Descent Angle 2.98 [^]	369	474	527	633	738	843			
MAP at D0.7 IKHE									

TERPS	.TERPS.		STRAIGHT-IN LANDING RWY36R		.CEILING. REQUIRED.		CIRCLE-TO-LAND	
	LOC (GS out)				Not Authorized East of Rwy 18L/36R			
	MDA(H) 420' (413')							
	CEIL-VIS		ALS out		Max Kts			
	A	500' - RVR 24 or 1/2	500' - RVR 55 or 1	90	520' (507')	600' - 1		
B			120	580' (567')	600' - 1			
C	500' - RVR 40 or 3/4		140	1360' (1347')	1400' - 3			
D		500' - RVR 60 or 1/8	165	1700' (1687')	1700' - 3			

CHANGES: CNF ident.

JEPPESSEN, 2009, 2021. ALL RIGHTS RESERVED.

RKPK/PUS
GIMHAE INTL

JEPPESEN
23 JUL 21 (11-8)

BUSAN, KOREA
LOC DME Z Rwy 36R

*D-ATIS 126.6	GIMHAE Arrival 119.2 134.4	GIMHAE Approach (R) 125.5	GIMHAE Tower 118.1 118.45	Ground 121.9
LOC IKHE 109.5	Final Apch Crs 001 [^]	NEIAN 2100' (2093')	MDA(H) 420' (413')	Apt Elev 13' Rwy 7'
MISSED APCH: Climb to 700', then LEFT turn direct to Opono at 6000', then track 231 [^] to GAYHA at 6000', then track 166 [^] to KEVOX and hold. Missed Apch requires minimum climb of 350' /NM to 6000'.				5200 MSA ARP
Alt set: hPa TDZ Elev: 0 hPa Trans level: FL 140 Trans alt: 14000'				
1. GNSS and Radar required. 2. RNAV 1.0 required. 3. Circling is not authorized east of Rwy 18/36. 4. Approach limited to MAX 230 KT and missed approach to MAX 210 KT. 5. Use IKHE DME when on the localizer course.				

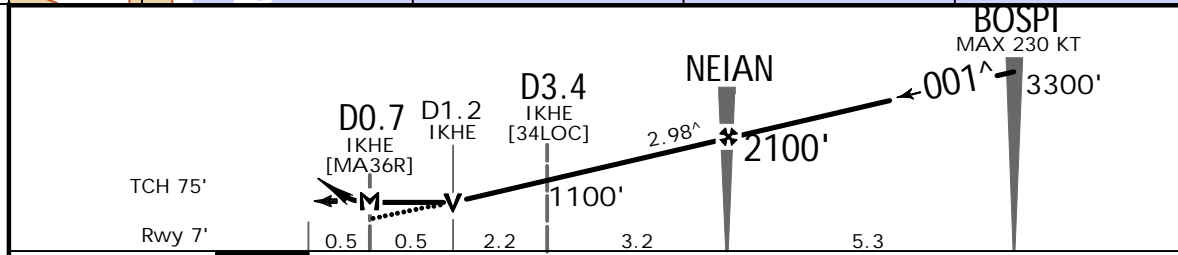
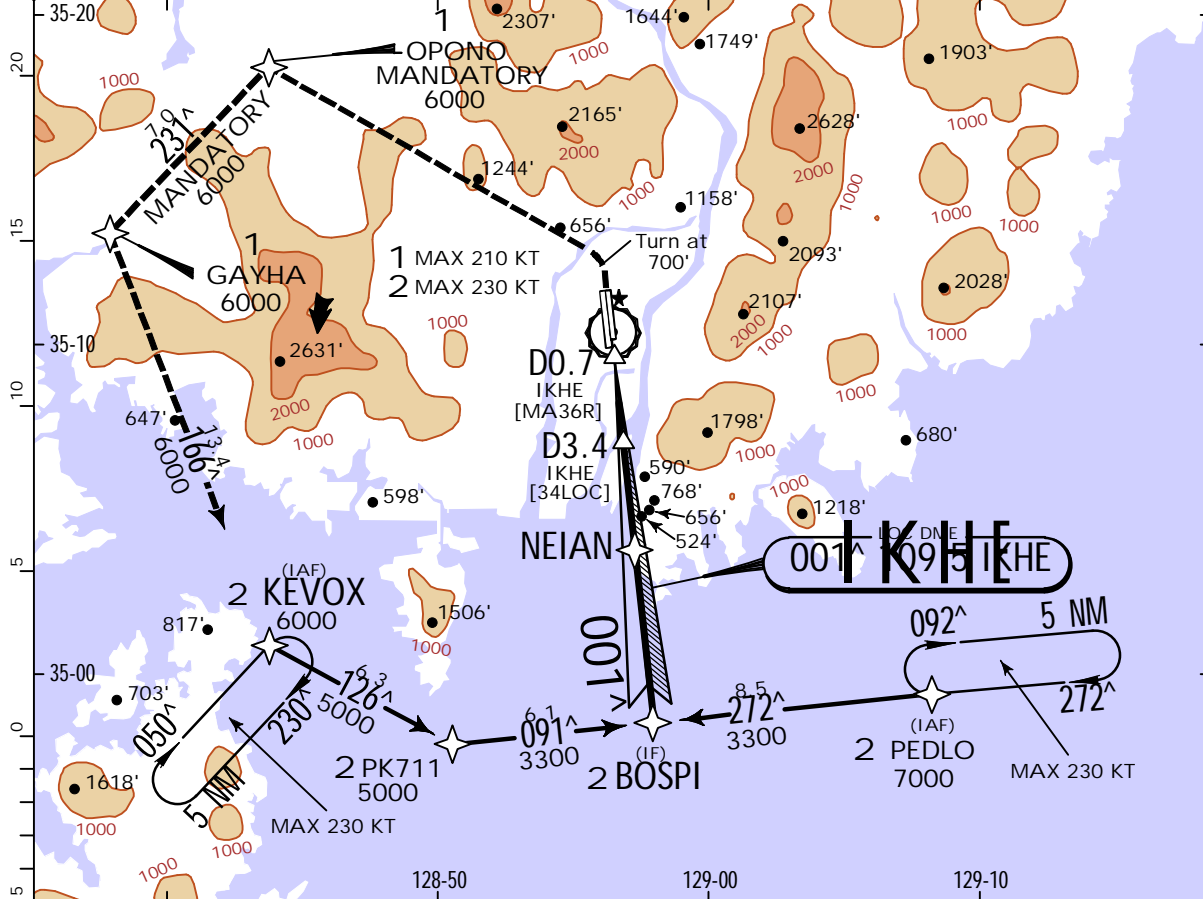

Gnd speed-Kts	70	90	100	120	140	160
Descent Angle 2.98 [^]	369	474	527	633	738	843
MAP at D0.7 IKHE						

.TERPS.		STRAIGHT-IN LANDING RWY36R		.CEILING REQUIRED.		CIRCLE-TO-LAND	
LOC (GS out)				Not Authorized East of Rwy 18/36			
MDA(H) 420' (413')							
CEIL-VIS		ALS out		Max Kts		MDA(H) CEIL-VIS	
A	500' - RVR 24 or 1/2	500' - RVR 55 or 1	90	520' (507')	600' - 1		
B			120	580' (567')	600' - 1		
C	500' - RVR 40 or 3/4	500' - RVR 60 or 1/8	140	1360' (1347')	1400' - 3		
D			165	1700' (1687')	1700' - 3		

RKPK/PUS
GIMHAE INTL

JEPPESEN
9 JUL 21
Eff. 14 Jul. 1600Z. (11-9)

BUSAN, KOREA
ILS Rwy 36L CAT II

*D-ATIS 126.6	GIMHAE Arrival 119.2 134.4	GIMHAE Approach (R) 125.5	GIMHAE Tower 118.1 118.45	Ground 121.9
LOC IKMA 108.5	Final Apch Crs 001 [^]	OLMOG 2100' (2087')	CAT II ILS RA 102' DA(H) 113' (100')	Apt Elev 13' TDZE 13'
MISSED APCH: Climb to 500', then climbing LEFT to 5000' direct Opono, then track 231 [^] to GAYHA, then track 166 [^] to KEVOX and hold. Missed Apch requires minimum climb of 420'/NM to 5000'. If unable to meet climb gradient, advise ATC and see ILS Y Rwy 36L or ILS Z Rwy 36L.				5200 MSA ARP
Alt set: hPa TDZ Elev: 0 hPa Trans level: FL 140 Trans alt: 14000'				
RNAV 1				
1. Special Aircrew & Acft Certification Required. 2. GNSS and Radar required. 3. Circling is not authorized. 4. Approach limited to MAX 230 KT and missed approach to MAX 210 KT. 5. VGSI and ILS glidepath not coincident (VGSI angle 3.00 [^] TCH 67').				

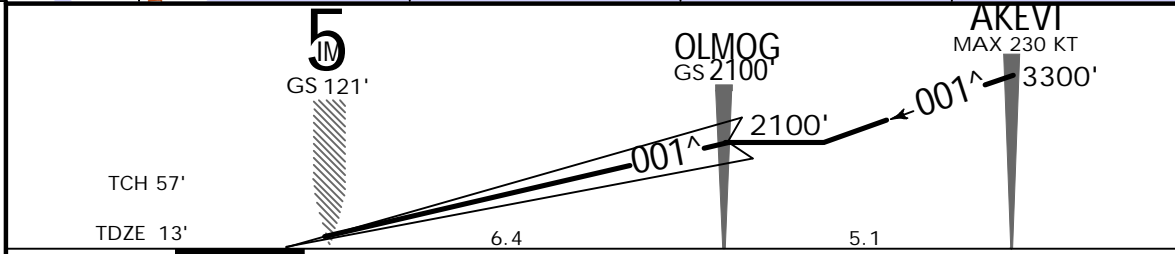
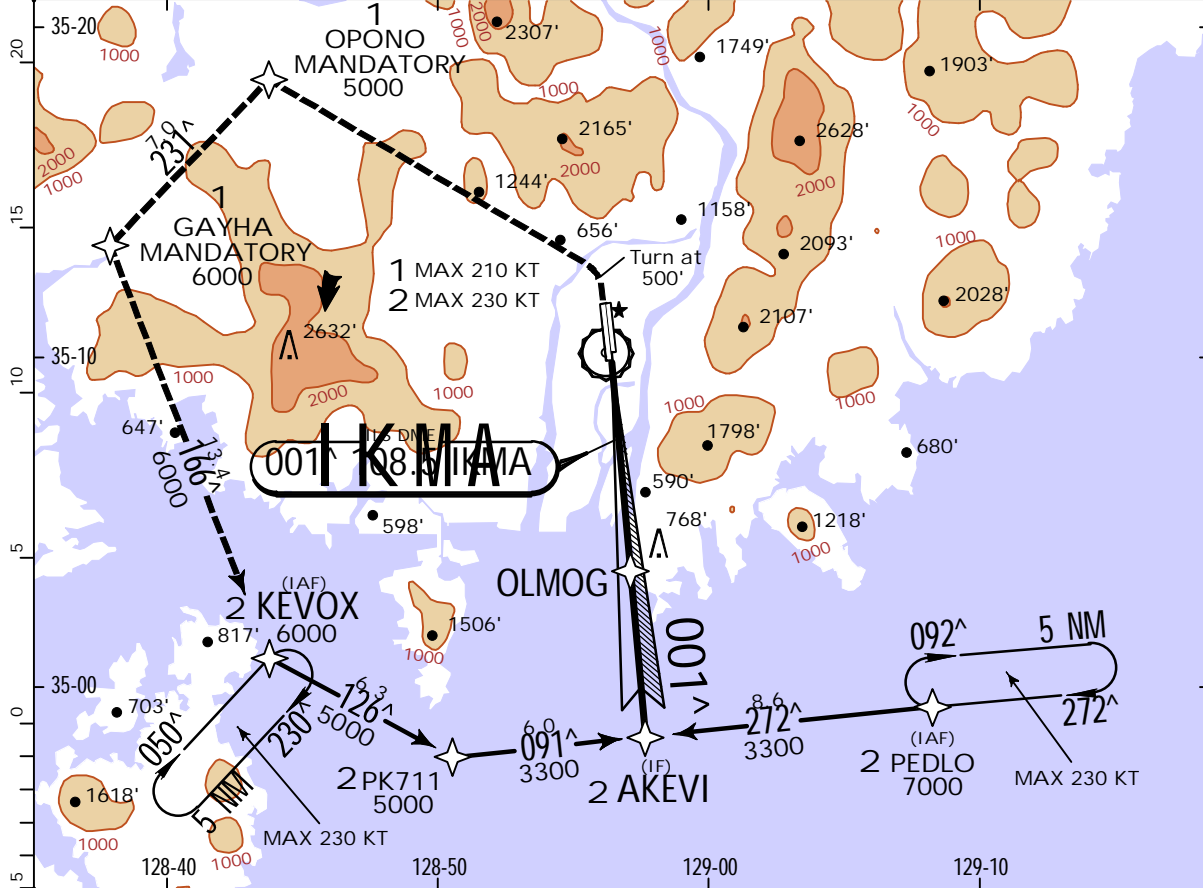

Gnd speed-Kts	70	90	100	120	140	160	ALSF-II PAPI	500' then 5000' ↑ then ↓ LT	D → Opono
GS	3.00 [^]	372	478	531	637	849			

STRAIGHT-IN LANDING RWY 36L
CAT II ILS
RA 102'
DA(H) 113' (100')

RVR 12

RKPK/PUS GIMHAE INTL



9 JUL 21 (12-1) Eff. 14 Jul 1600Z

BUSAN, KOREA RNP Rwy 36L

*D-ATIS 126.6	GIMHAE Arrival 119.2 134.4		GIMHAE Approach (R) 125.5	GIMHAE Tower 118.1 118.45	Ground 121.9
RNAV	Final Apch Crs 001 [^]	OLMOG 2100' (2088')	LNAV/VNAV DA(H) 420' (408')	Apt Elev 13' Rwy 12'	5200
MISSED APCH: Climb to 6000' on track 001 [^] to PK723, then track 310 [^] to cross OPONO at 6000', then track 231 [^] to GAYHA, then track 166 [^] to KEVOX and hold. Missed Apch requires minimum climb of 390' /NM to 6000'.					
Alt set: hPa Rwy Elev: 0 hPa Trans level: FL 140 Trans alt: 14000'					
RNP Apch RNP 0.30, GNSS and RADAR required					
1. DME/DME RNP 0.30 not authorized. 2. Initial and missed approach limited to MAX 230 KT. 3. For uncompensated Baro-VNAV systems, LNAV/VNAV not authorized below -18°C or above 54°C. 4. VGSI and RNAV glidepath not coincident.					MSA ARP

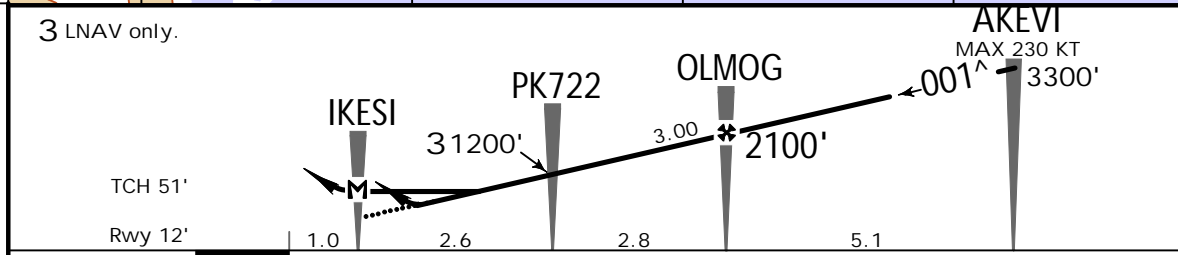
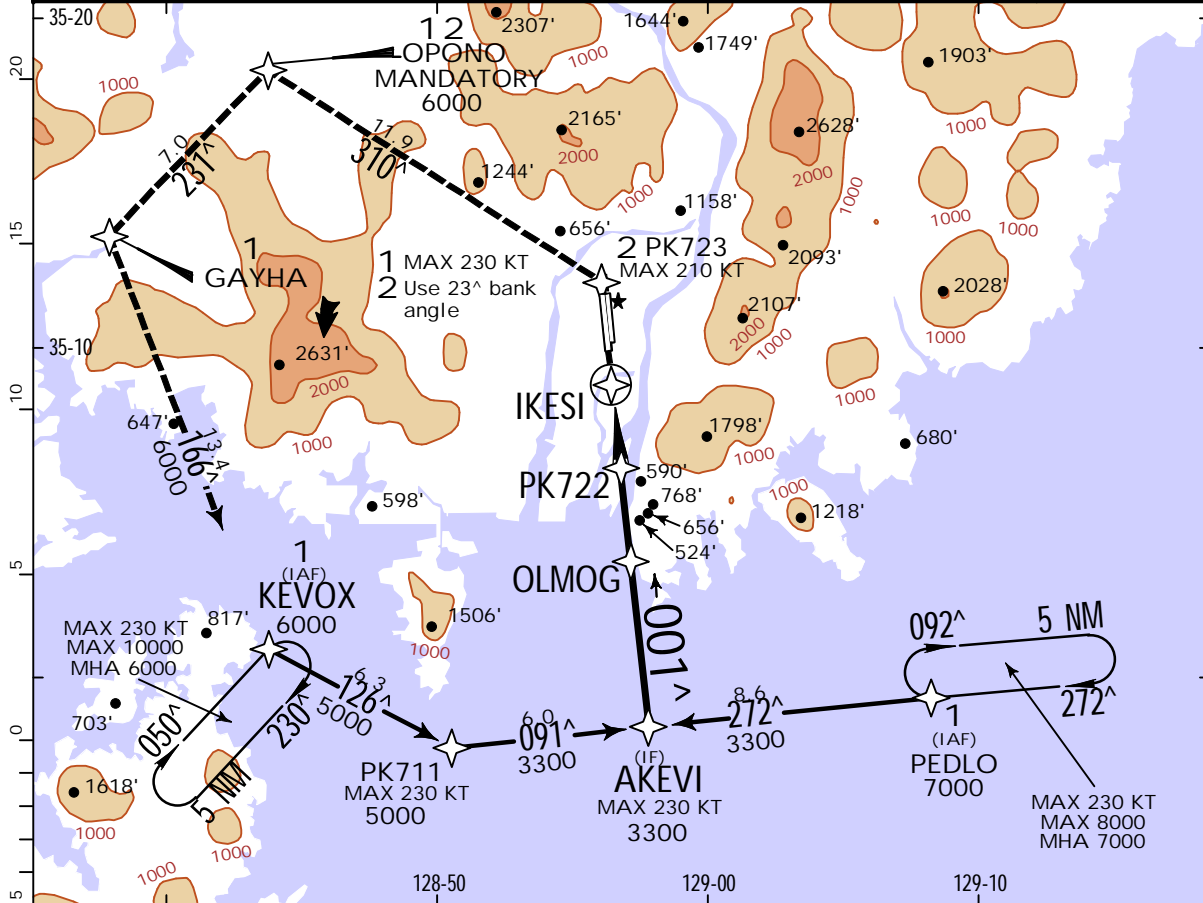

Gnd speed-Kts	70	90	100	120	140	160	ALSF-II PAPI	6000' on track	001 [^] PK723
Descent Angle	3.00 [^]	372	478	531	637	849			

.TERPS. STRAIGHT-IN LANDING RWY 36L .CEILING.REQUIRED. CIRCLE-TO-LAND

LNAV/VNAV DA(H) 420' (408')		LNAV MDA(H) 500' (488')		Not Authorized East of Rwy 18/36	
ALS out		ALS out			
A		500' - RVR 45 or 7/8	500' - 1 1/2	90	580' (567') 600'-1 1/2
B	500' - RVR 45 or 7/8	500' - 1 3/8		120	
C			500' - RVR 55 or 1	140	1360' (1347') 1400'-3
D				165	1700' (1687') 1700'-3

CHANGES: Waypoints idents.

JEPPesen, 2017, 2021. ALL RIGHTS RESERVED.

RKPK/PUS
GIMHAE INTL

JEPPESSEN
9 JUL 21 (12-2) Eff. 14 Jul 1600Z

BUSAN, KOREA
RNP Rwy 36R

*D-ATIS 126.6	GIMHAE Arrival 119.2 134.4	GIMHAE Approach (R) 125.5	GIMHAE Tower 118.1 118.45	Ground 121.9
RNAV	Final Apch Crs 001 [^]	NEIAN 2100' (2093')	LNAV/VNAV DA(H) 420' (413')	Apt Elev 13' Rwy 7'
MISSED APCH: Climb to 6000' on track 001 [^] to PK713, then track 310 [^] to Opono, then track 231 [^] to Gayha, then track 166 [^] to KEVOX and hold. Missed Apch requires minimum climb of 330' /NM to 6000'.				5200 MSA RWY36R
Alt set: hPa Rwy Elev: 0 hPa Trans level: FL 140 Trans alt: 14000'				
RNP Apch RNP 0.30, GNSS and Radar required				
1. DME/DME RNP 0.30 not authorized. 2. Initial and missed approach limited to MAX 230 KT. 3. For uncompensated Baro-VNAV systems, LNAV/VNAV not authorized below -18°C or above 54°C. 4. VGSI and RNAV glidepath not coincident.				

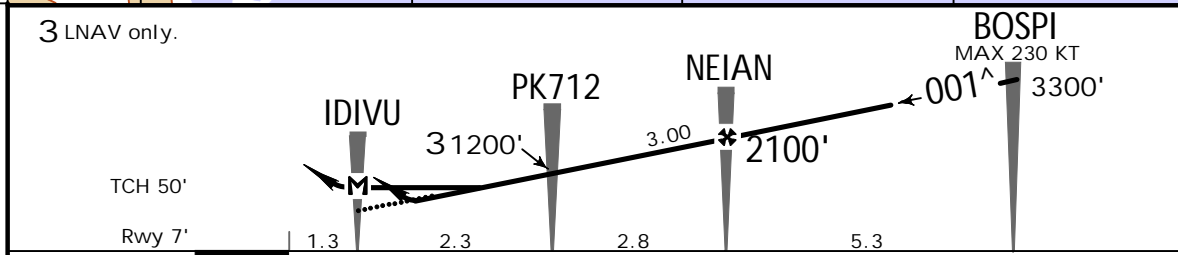
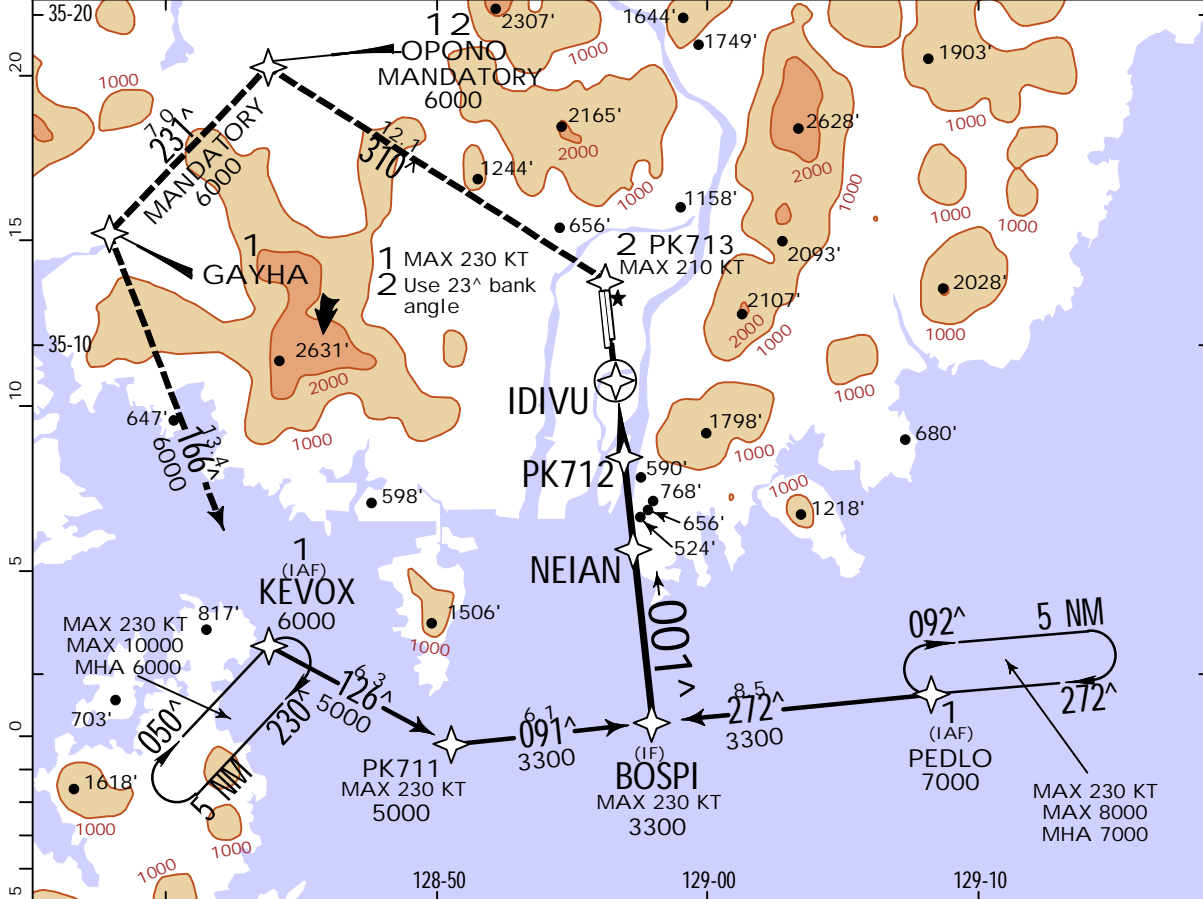

Gnd speed-Kts	70	90	100	120	140	160	ALSF-II PAPI 6000' on 001 [^] track PK713
Descent Angle 3.00 [^]	372	478	531	637	743	849	
MAP at IDIVU							

.TERPS.				STRAIGHT-IN LANDING RWY 36R		.CEILING REQUIRED.		CIRCLE-TO-LAND	
LNAV/VNAV DA(H) 420' (413')		LNAV MDA(H) 600' (593')		Not Authorized East of Rwy 18/36 Max Kts: 90, 120, 140, 165		MDA(H) CEIL-VIS 600' (587') 600'-1 7/8 1360' (1347') 1400'-3 1700' (1687') 1700'-3			
A	ALS out		ALS out						
B	500' - RVR 55 or 1	500' - RVR 60 or 1 1/4	600' - 1 1/2	600' - 1 7/8					
C									
D									

RKPK/PUS
GIMHAE INTL

JEPESEN
9 JUL 21 (12-3) Eff. 14 Jul 1600Z

BUSAN, KOREA
RNP B Rwy 18L/R

BRIEFING STRIP™	*D-ATIS	GIMHAE Arrival		GIMHAE Approach (R)		GIMHAE Tower		Ground	
	126.6	119.2	134.4	125.5		118.1	118.45	121.9	
	RNAV	Final Apch Crs 045^	WAYBI 2600' (2587')		MDA(H) Refer to Minimums	Apt Elev 13'		5200	
	MISSED APCH: Climb to 6000' via track 045^ to PK733 and track 315^ to PK734, then track 231^ to GAYHA and hold.								
	Alt set: hPa		Apt Elev: 0 hPa		Trans level: FL 140		Trans alt: 14000'		
RNP Apch		GNSS, RNP 0.30 and Radar required						MSA ARP	
DME/DME RNP 0.30 not authorized.									

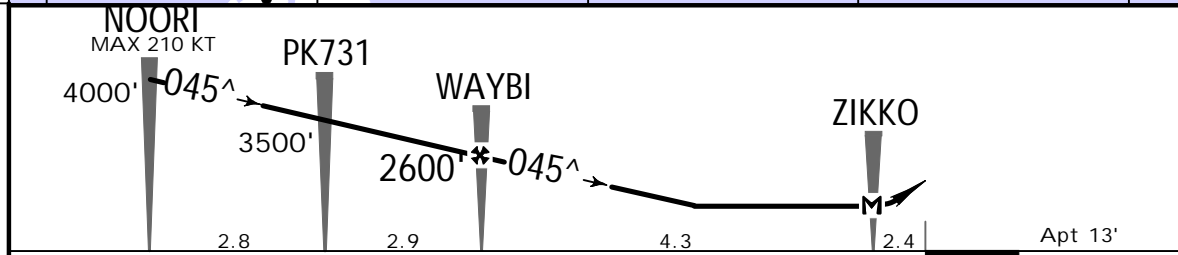

Lighting - Refer to Airport Chart	6000' via 045^ track	PK733
MAP at ZIKKO		

TERPS.		STRAIGHT-IN LANDING		CEILING REQUIRED.		CIRCLE-TO-LAND	
LNAV/VNAV		LNAV		Not Authorized east of Rwy 18/36 Not Authorized to Rwy 36L/R		MDA(H) ——— CEIL-VIS ———	
A	NA	NA	NA	1700'	(1687')	1700'- 3	Max Kts
B							
C							
D							

CHANGES: Waypoint ident.

RKPK/PUS
GIMHAE INTL

JEPPESSEN
28 MAY 21 (13-1)

BUSAN, KOREA
VOR DME Rwy 36L

*D-ATIS 126.6	GIMHAE Arrival 119.2 134.4	GIMHAE Approach (R) 125.5	GIMHAE Tower 118.1 118.45	Ground 121.9
VOR KMH 113.8	Final Apch Crs 001 [^]	D8.4 2100' (2088')	MDA(H) 1460' (1448')	Apt Elev 13' Rwy 12'
MISSED APCH: Climb to 1600' then LEFT turn climbing to 6000' on KMH VOR R-310 outbound to D15.0 KMH, then track KMH VOR D15.0 Arc to GEOJE and hold.				
Alt set: hPa	TDZ Elev: 0 hPa	Trans level: FL 140	Trans alt: 14000'	
				MSA KMH VOR

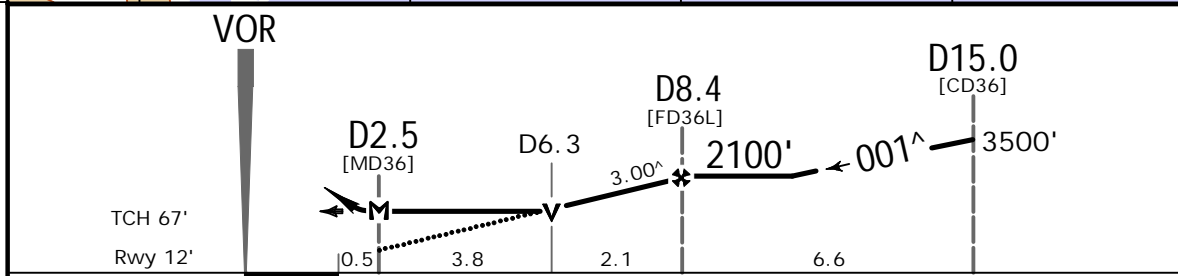
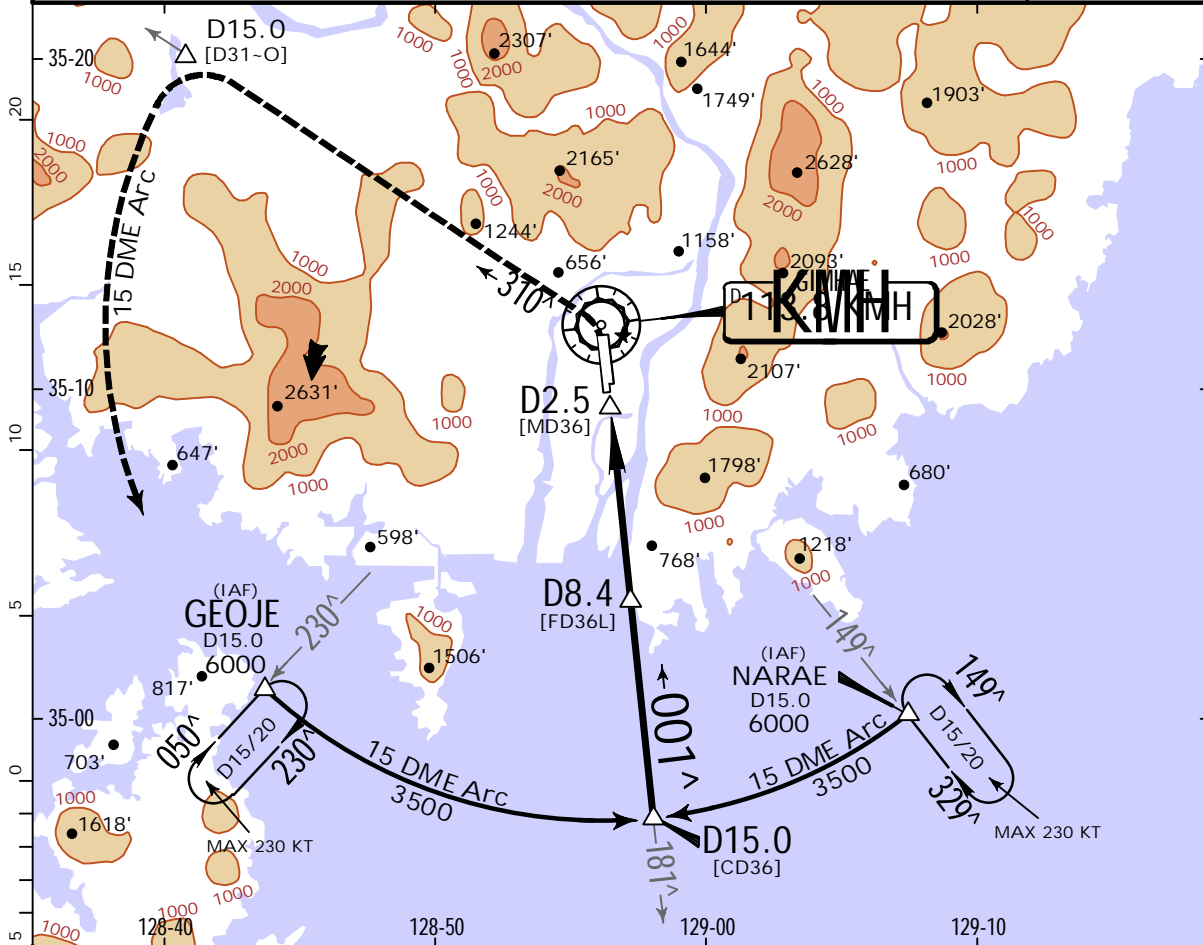

Gnd speed-Kts	70	90	100	120	140	160	ALSF-II PAPI	1600'	6000'	KMH 113.8	D15.0
Descent Angle	3.00 [^]	372	478	531	637	849					
MAP at D2.5											

TERPS	STRAIGHT-IN LANDING RWY 36L		.CEILING. REQUIRED.		CIRCLE-TO-LAND	
	MDA(H) 1460' (1448')		Not Authorized East of Rwy 18/36			
	CEIL-VIS		ALS out		Max Kts	
	A	1500' - RVR 40 or 3/4	1500' - RVR 60 or 1/4	90	1460' (1447')	1500' - 1 1/4
	B	1500' - RVR 55 or 1	1500' - 1 1/2	120	1460' (1447')	1500' - 1 1/2
C	1500' - 3		140	1460' (1447')	1500' - 3	
D			165	1700' (1687')	1700' - 3	

RKPK/PUS
GIMHAE INTL

JEPPESEN
28 MAY 21 **13-2**

BUSAN, KOREA
VOR DME Rwy 36R

*D-ATIS 126.6	GIMHAE Arrival 119.2 134.4	GIMHAE Approach (R) 125.5	GIMHAE Tower 118.1 118.45	Ground 121.9
VOR KMH 113.8	Final Apch Crs 001 [^]	D8.2 2100' (2093')	MDA(H) 1460' (1453')	Apt Elev 13' Rwy 7'
MISSED APCH: Climb to 1600' then LEFT turn climbing to 6000' on KMH VOR R-310 outbound to D15.0 KMH, then track KMH VOR D15.0 Arc to GEOJE and hold.				
Alt set: hPa	TDZ Elev: 0 hPa	Trans level: FL 140	Trans alt: 14000'	
				MSA KMH VOR

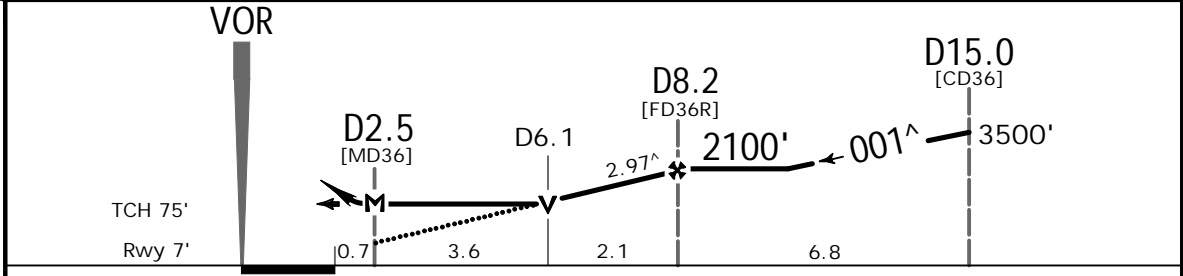
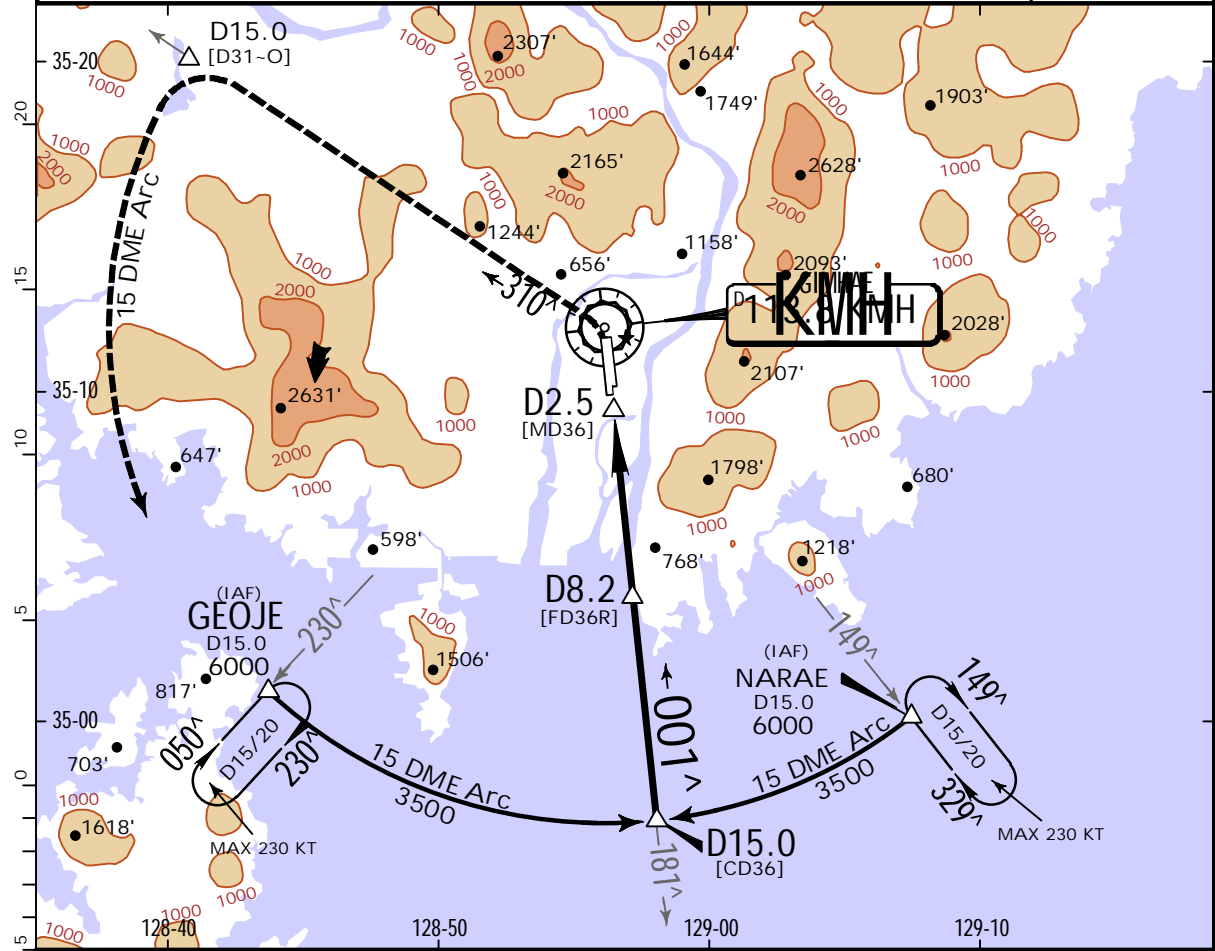

Gnd speed-Kts	70	90	100	120	140	160	ALSF-II PAPI	1600'	6000'	KMH 113.8	D15.0
Descent Angle	2.97 [^]	368	473	525	630	841					
MAP at D2.5											

TERPS		STRAIGHT-IN LANDING RWY 36R		.CEILING. REQUIRED.		CIRCLE-TO-LAND	
		MDA(H) 1460' (1453')				Not Authorized East of Rwy 18/36	
		ALS out				Max Kts	
A	1500' - RVR 40 or 3/4	1500' - RVR 60 or 1/4		90	1460' (1447')	1500' - 1 1/4	
B	1500' - RVR 55 or 1	1500' - 1 1/2		120	1460' (1447')	1500' - 1 1/2	
C	1500' - 3			140	1460' (1447')	1500' - 3	
D				165	1700' (1687')	1700' - 3	

CHANGES: Minimums.

RKPK/PUS
GIMHAE INTL

JEPPESSEN
29 OCT 10 (19-1)

BUSAN, KOREA
VISUAL APCH

BRIEFING STRIP™	*D-ATIS 126.6	GIMHAE Arrival 119.2 134.4		GIMHAE Approach (R) 125.5	GIMHAE Tower 118.1 118.45	Ground 121.9
	NAVAIDS- Refer to Planview	Final Apch Crs NOT APPLICABLE	No FAF	CEIL-VIS NOT APPLICABLE	Apt Elev 13'	
	MISSED APCH: No missed approach procedure.					
Alt Set: hPa		Trans level: FL 140		Trans alt: 14000'		MSA KMV VOR
1. PAPI on Rwy 18L/R unserviceable beyond 2 NM from PAPI location due to terrain.						

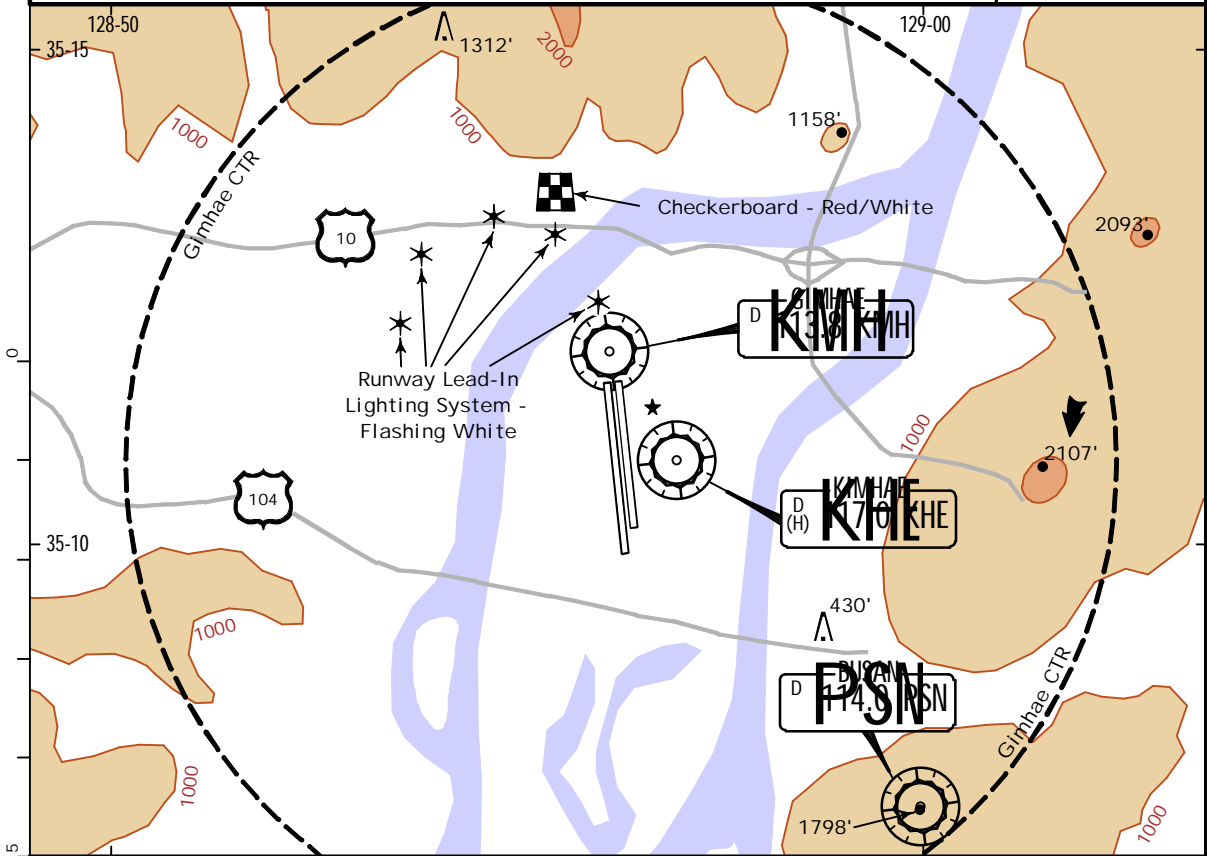

ATC Airspace Classifications

- Class C: Radius of airport with Airport Control
 - Vertical limits
 - Within 5 NM (SFC - 5,000' AGL).
 - Within 5 NM - 10 NM (1,000' AGL - 5,000' AGL).
 - Speed limits: 250 KIAS or less at or below 10,000' MSL
 - 200 KIAS or less at or below 2,500' MSL within 4 NM of the airport.
- Class D: Radius of airport with no Airport Control
 - Vertical limits
 - Within 5 NM (SFC - 5,000' AGL or the upper limits of the control zone).
 - Speed limits: 250 KIAS or less at or below 10,000' MSL
 - 200 KIAS or less at or below 2,500' MSL within 4 NM of the airport.
- Class E: Controlled Airspace except Class A, B, C and D
 - Vertical limits
 - Airspace (Land and Water): 1,000' - 60,000' from the surface of the earth or sea.
 - Airspace over the high seas: 5,500' from the surface of the sea - 60,000' MSL.
 - Speed limits: 250 KIAS or less at or below 10,000' MSL.

Lighting -
Refer to
Airport
Chart

TERPS

NOT APPLICABLE

Chart changes since cycle 06-2023

ADD = added chart, REV = revised chart, DEL = deleted chart.

ACT	PROCEDURE IDENT	INDEX	REV DATE	EFF DATE
BUSAN, (GIMHAE INTL - RKPK)				
REV	ATLAX 2 DEP	10-3	31 Mar 2023	
REV	BAHDA 1 DEP	10-3A	31 Mar 2023	
REV	GIMHAE 2 DEP	10-3D	31 Mar 2023	
REV	OPONO 3 RNAV DEP	10-3E	31 Mar 2023	

TERMINAL CHART CHANGE NOTICES

Chart Change Notices for Airport RKPK

Type: Terminal

Effectivity: Temporary

Begin Date: Immediately

End Date: 20230330

(10-3A) BAHDA 1 SID & (10-3D) GIMHAE 2 SID: airway Y-579 withdrawn.

Type: Terminal

Effectivity: Temporary

Begin Date: Immediately

End Date: 20230629

TWY W1 is closed due to suspension of operation, from 1500 UTC 29 JUN 2022 to 1500 UTC 29 JUN 2023.